

**CONTENDER**

**STEP UP TO THE PLATE**



**CONTENDER GLASSWASHER**

**DMG005 – CONTENDER PRO400 COMMERCIAL GLASSWASHER**

# CONTENTS

I.	AIMS AND SCOPE.....	4
2.	RESPONSIBILITIES .....	4
3.	SIGNS .....	4
4.	TECHNICAL DATA (BASIC FEATURES) .....	5
5.	TRANSPORTATION AND INSTALLATION .....	7
6.	GENERAL PRINCIPLES.....	7
7.	PACKAGE CONTENTS .....	8
8.	DESCRIPTION OF DEVICE WITH EXPLANATIONS .....	9
9.	COMPLIANCE .....	9
10.	REPLACING THE DEVICE AND PREPARING FOR START UP .....	9
	INSTALLATION BEFORE ASSEMBLING	
	PREPARATION FOR START UP	
	FINAL CHECK BEFORE START UP	
II.	START UP .....	11
12.	ELECTRICAL DIAGRAM.....	12
13.	MAINTENANCE AND CLEANING .....	13
	DAILY MAINTENANCE	
	CLEANING THE DEVICE	
	WEEKLY MAINTENANCE	
14.	SAFE LIFE .....	14
15.	INTERVENTION AFTER FAILURE.....	14
16.	SPARE PARTS LIST .....	16





# I. AIMS AND SCOPE





DESCRIPTIONS FOR SAFE USE AND MAINTENANCE OF THE PRODUCT



## 2. RESPONSIBILITIES

**RESPONSIBILITIES OF PRODUCT OWNER:** THE PRODUCT'S OWNER IS RESPONSIBLE FOR APPLYING OF SAFETY RULES STATED IN THIS INSTRUCTION MANUAL OR GETTING THEM APPLIED BY DELEGATING HIS AUTHORITIES AND RISKS, WHICH MAY ARISE DUE TO NOT APPLYING. THE PRODUCT'S OWNER IS ALSO RESPONSIBLE FOR THE PERIODICAL MAINTENANCE OF THE MACHINE.

**RESPONSIBILITIES OF THE MANUFACTURER:** THE MANUFACTURER IS RESPONSIBLE FOR THE RISKS DUE TO MANUFACTURING AND ASSEMBLING FAULTS, EVEN THOUGH ALL REQUIREMENTS STATED IN THIS MANUAL HAVE BEEN FULFILLED.

## 3. SIGNS

	<b>WARNING:</b> THIS SIGN INDICATES THAT IT MUST BE COMPLIED WITH THE INSTRUCTIONS RELATED TO THE SUBJECT; OTHERWISE, THE RISKY CONDITIONS, IN WHICH THERE CAN OCCUR SOME DAMAGES AND DANGERS
	<b>CAUTION:</b> THIS SIGN INDICATES ANY RISKY CONDITIONS, WHICH CAN CAUSE DAMAGES IN MATERIAL AND INJURING OF PEOPLE, PROVIDED THAT ONE DOES NOT PAY ATTENTION AND STATES THAT ONE MUST BE CAREFUL
	<b>DANGER:</b> THIS SIGN INDICATES HIGH RISKY CONDITIONS IN WHICH PEOPLE CAN BE INJURED, PROVIDED THAT ONE DOES NOT PAY ATTENTION AND THE RULES ALWAYS TO BE COMPLIED WITH.
	<b>DANGER:</b> THIS SIGN INDICATES HIGH RISKY CONDITIONS IN WHICH THE PEOPLE CAN BE INJURED OR CAN DIE DUE TO ELECTRICAL SHOCK.
	<b>EQUIPOTENTIAL CONNECTION TERMINAL</b> (IF NECESSARY, IT MUST BE CONNECTED TO OTHER EQUIPMENT TO MAKE EQUAL THE POTENTIAL)

<b>A</b>				
<b>B</b>	Mod:	SN:		<b>F</b>
<b>C</b>	Volt:	Gas: gr	Class:	
<b>D</b>	P(H <sub>2</sub> O) = ( )x101 kPa ( Bar)	MADE IN  		
<b>E</b>	Kw:	IPX	TURKEY	
	<b>J</b>	<b>K</b>	<b>L</b>	<b>M</b>

- A** COMPANY INFORMATION
- B** MODEL
- C** ENERGY
- D** PRESSURE
- E** POWER
- F** SERIAL NUMBER\*
- G** CONSUMPTED GAS AND AMOUNT

- H** CLASS
- J** IP CLASS
- K** PRODUCTION LOCATION
- L** CE SIGN
- M** WEEE SIGN

\* FIRST THREE NUMBERS ARE GROUP CODES. 4TH AND 5TH NUMBERS ARE YEAR OF PRODUCTION. 6TH & 7TH NUMBERS ARE THE MONTH OF PRODUCTION. 8TH, 9TH & 10TH NUMBERS ARE THE SERIAL NUMBER.



# 4. TECHNICAL DATA

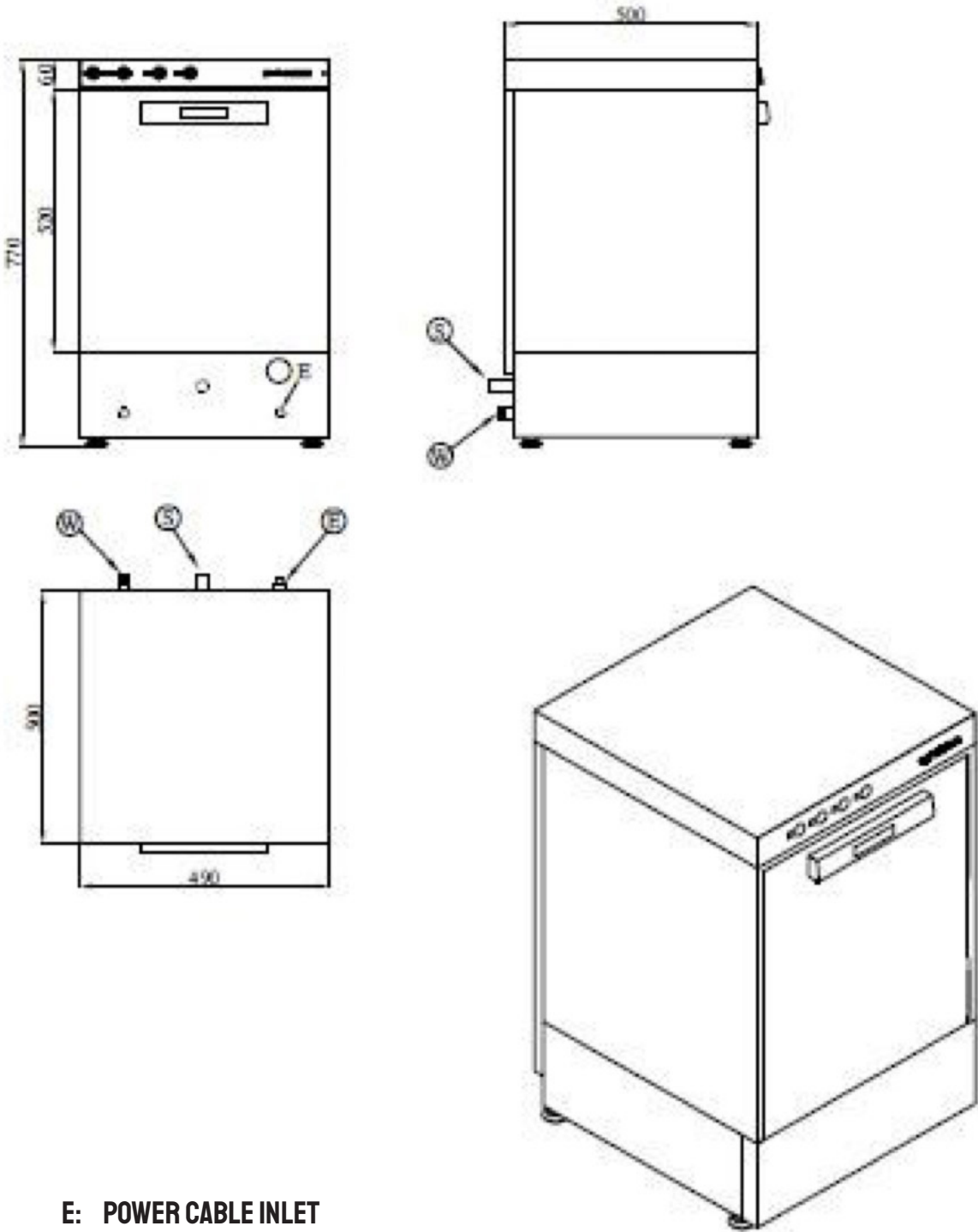





- E: POWER CABLE INLET
- W: WATER INLET
- S: WATER OUTLET

## 4. TECHNICAL DATA













MODEL		DMG005	
<b>CAPACITY</b>			
GLASSWARE		60'	1200
<b>BASKET</b>			
GLASS-CUP BASKET	37X37	N	2
<b>ELECTRIC</b>			
VOLTAGE		V	220-230 AC V, 3- N, 50HZ
WASHING TANK HEATER		W	1800
RINSING WATER HEATER		W	2500
MAXIMUM POWER		W	2700
MAIN SUPPLY CABLE		MM <sup>2</sup>	3X2.5 RNF TYPE
<b>FEED WATER</b>			
WATER INLET PRESSURE		BAR	2-4
WATER HARDNESS		°FR	15
WATER INLET TEMPERATURE		°C	45-50
WATER INLET CONNECTOR DIAMETER		Ø	¾"
WATER INLET CONNECTOR DIAMETER		ØMM	32
DRAINAGE HEIGHT		CM	50
<b>WASHING</b>			
TEMPERATURE		°C	50-55
WASHING TANK CAPACITY		IT	11
WASHING PUMP		HP	0,25
WASHING DURATION		MINS	2
<b>RINSING</b>			
TEMPERATURE		°C	80-85
RINSING WATER CONSUMPTION		IT/BASKET	2,5
LENGTH		CM	42
WIDTH		CM	50
HEIGHT		CM	75
GROSS WEIGHT		KG	20
VOLUME		M <sup>3</sup>	0.42















## 5. TRANSPORT & INSTALLATION

	DURING TRANSPORTATION, TAKE NECESSARY PRECAUTIONS AGAINST THE RISK OF THE PRODUCT FALLING DOWN AND BEING TURNED UPSIDE DOWN.
	PLACE THE PRODUCT ONTO A FLAT AND SOLID GROUND.
	DO NOT INSTALL THE PRODUCT NEAR THE FLAMMABLE AND EXPLOSIVE MATERIALS AND DO NOT KEEP ANY FLAMMABLE AND EXPLOSIVE MATERIAL NEAR THE FURNACE, WHILE IT IS WORKING.
	KEEP A FIRE EXTINGUISHER NEAR THE FURNACE AND CHECK WHETHER THE PERIODICAL CHECKING OF THE FIRE EXTINGUISHER HAS BEEN IMPLEMENTED OR NOT.

## 6. GENERAL PRINCIPLES

-  THE USERS AGREE AND ACCEPT TO BE IN CONFORMITY WITH ALL REQUIREMENTS INCLUDED IN USING MANUAL, OTHERWISE THE MACHINE SHALL BE DEEMED OUT OF GUARANTEE COVERAGE.
-  THE USER ALSO ACCEPTS THAT HE/SHE WAS FULLY INFORMED ABOUT THE LIMITED GUARANTEE LIABILITY.
-  ANY LIVING BODY OR ANY OBJECT SHOULD NOT BE PLACED ON MACHINES. IN ADDITION, ANY LIVING BODY SHOULD NOT BE PUT INSIDE THE MACHINES.
-  CHILDREN OR ANY OTHER UNAUTHORISED PERSONS SHOULD NOT BE ALLOWED THE TO OPERATE THE MACHINE.
-  ANY ELECTRICAL OPERATING MACHINES SHOULD BE CLEANED AFTER THE REQUIRED ELECTRICAL CONNECTIONS SWITCHED OFF.
-  THE ELECTRICAL PRODUCTS SHOULD NEVER BE OPERATED IF ANY SUFFICIENT GROUNDING INSTALLATION HAD NOT BEEN PRACTICED IN ADDITION; THE LEAK CURRENT RELAY AND FUSE GROUPS HAD NOT BEEN INSTALLED IN CONTROL BOX SUPPLYING THE ELECTRICAL ENERGY TO THE MACHINE.
-  THE COVER OF ANY MACHINE SHOULD NOT BE OPENED DURING THE PERIOD OF WORKING.
-  USE FOAM FREE AND FOAM CONTROLLED LIQUID DETERGENT AND POLISHER IN YOUR MACHINE. WHILE THE DEVICE IS WORKING, DO NOT OPEN IN ANY WAY THE COVER OF THE DEVICE WITH COVER.
-  BE CAREFUL NOT TO TRAP YOUR HANDS WHILE CLOSING THE COVERS.
-  THE MACHINES AND COVERS SHOULD NOT BE TREATED AS STEP OR LADDER IN ANY CASE.
-  THE ELECTRICAL DEVICES SHOULD NEVER BE WASHED IN THE MANNER OF SPRAYING WATER. THEY SHOULD BE CLEANED BY MEANS OF RUBBING AFTER SWITCHING THE POWER OFF THE POWER HAD BEEN SWITCHED OFF.
-  ANY SCRATCHIER OR STRIPPER TOOLS SHOULD NOT BE USED DURING THE CLEANING.

-  THIS MANUAL VERIFIES ALL MACHINES WERE TESTED AND THE REQUIRED SECURITY CONTROLS WERE DONE IN DUE DILIGENCE SO DELIVERED UNDER OPERATING CONDITIONS.
-  DO NOT CONNECT THE DEVICES, WHICH ARE IN CONNECTION WITH HOSE, TO THE WATERLINES IN THE TEMPERATURES BELOW – 5°C AND ABOVE 50°C.
-  USE RUBBER GLOVES DURING THE CLEANING AND MAINTENANCE PRACTICES PROCEDURES
-  DO NOT REMOVE THE LABELS AND PANELS OF THE DEVICES.
-  IN ORDER TO USE EFFICIENTLY AND TO DECREASE MINIMUM THE ENERGY EXPENSES, SUPPLY WATER IN 50°C TO YOUR DEVICES WITH AN ELECTRICAL HEATING SYSTEM. ADDITIONALLY, IN ORDER TO ELONGATE THE LIFE OF YOUR DEVICE, USE SURELY SOFT WATER IN 15 °F IF YOU DO NOT HAVE THE WATER IN THIS SOFTNESS, USE A WATER SOFTENING DEVICE.
-  THE MANUFACTURER HAS THE RIGHT TO MAKE ALL CHANGES, WHICH HE/SHE DEEMS TO BE USEFUL FOR USER OR HIM/HER. HOWEVER, HE/SHE GUARANTEES THAT THE FEATURES RELATED TO PRIMARY FUNCTIONALITY AND SAFETY OF THE DEVICE WILL BE MAINTAINED.
-  IN CASE OF ANY FAILURE, CUT THE ELECTRICAL AND WATER CONNECTION OF THE DEVICE OFF AND APPLY TO THE AUTHORISED SERVICES.
-  IN YOUR DEVICE, DO NOT WASH THE THINGS SUCH AS POTS AND PANS, SAUCEPANS IN DIFFERENT AND BIG SIZES, WHICH DO NOT FIT TO USE PURPOSE.
-  WHILE THE WATER IN THE BOILER OF YOUR DEVICE IS HOT, DO NOT INSERT YOUR HAND INTO THE BOILER. WATER THAT IS HOT AND CONTAINS DETERGENT CAN BE HARMFUL FOR YOUR SKIN. IN SUCH A CONDITION, RINSE YOUR HAND WITH WARM WATER.
-  POWER CORD MUST BE MIN. H05RN-F TYPE.
-  CABLE DIAMETER MUST BE MIN 3X2.5 MM2
-  GROUNDING LINE MUST BE CONTINUOUSLY CHECKED.

## 7. PACKAGE CONTENTS

- DESCRIPTION CATALOGUE
- USER MANUAL
- WATER SUPPLYING HOSE
- DRAINAGE HOSE TO SEWER SYSTEM
- BASKET

DEAR CUSTOMERS, PLEASE CHECK THE ABOVE WRITTEN AUXILIARY EQUIPMENT TO BE GIVEN WITH THE MACHINE ON DELIVERY. IF YOU NOTICE ANY DAMAGE OR LOSS OCCURRED DURING THE TRANSPORTATION THEN YOU SHOULD REQUEST THE TRANSPORTER TO ISSUE ANY WRITTEN REPORT INCLUDING THE RELEVANT DAMAGE OR LOSS.



## 8. DESCRIPTION OF DEVICE WITH EXPLANATIONS

- THIS WASHING MACHINE HAS BEEN MANUFACTURED TO HYGIENIC STANDARDS.
- THE FRAME (INSIDE/OUTSIDE), INCLUDING CHASSIS, PANEL AND BOILER, HAS BEEN WHOLLY MANUFACTURED FROM STAINLESS STEEL MATERIAL. THE LEGS ARE IN ADJUSTABLE FEATURE AND MANUFACTURED FROM STAINLESS STEEL MATERIAL.
- WASHING TANK IS AUTOMATICALLY FILLED AND CONTINUOUS LEVEL CONTROLLED.
- WASHING AND RINSING WATER TEMPERATURES ARE AUTOMATICALLY CONTROLLED VIA TWO THERMOSTATS WORKING INDEPENDENTLY. ITS PERFORMANCE AND EFFICIENCY ARE HIGHER THAN THOSE OF ITS COMPETITORS.
- PROGRAM DURATION IS 2 MIN.
- THE PUMPS HAVE BEEN MANUFACTURED AS DETERGENT AND HOT WATER RESISTANT.
- MOTORS HAVE A HEAT RESISTANT FEATURE AND ARE PROTECTED BY COOLING OF FAN AGAINST HIGHER TEMPERATURES.
- THE INSULATION OF BOILER HAS BEEN PROVIDED BY GLASS WOOL THAT IS A SPECIAL INSULATION MATERIAL. THUS, HEAT LOSSES CAN BE REDUCED TO MINIMUM LEVEL AND PREVENTED THE WASTING OF ENERGY AS WELL. SYSTEM HAS BEEN FULLY SECURED BY MEANS OF THERMAL AND ELECTRICAL PROTECTORS. ACCESS TO ELECTRICAL PANEL, EXECUTING OF MAINTENANCE WORKS AND INSPECTIONS HAVE BEEN QUITE FACILITATED. FULL AUTOMATICALLY WASHING HAS BEEN PERFORMED AT 55 °C. RINSING IS PERFORMED AT 80 TO 85°C BY HOT AND FRESH WATER. ELECTRICAL EQUIPMENT AND CABLES COMPLY WITH EUROPEAN STANDARDS AND SAFETY REGULATIONS.

## 9. COMPLIANCE

THESE PRODUCTS ARE CE CERTIFIED AND ARE IN COMPLIANCE WITH THE FOLLOWING DIRECTIVES:

2014/35/EU  
LOW VOLTAGE DIRECTIVE (AS AMENDED)





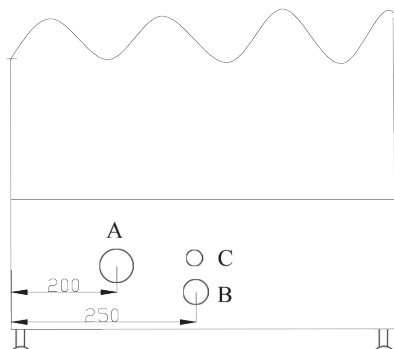













## 10. REPLACING THE DEVICE AND PREPARING FOR START UP INSTALLATION BEFORE ASSEMBLING



	DESCRIPTION
A	FRESH WATER INLET
B	WATER
C	POWER OUTLET CABLE

## PREPARATION FOR START UP

-  OPEN THE PACKING OF THE DEVICE AND REMOVE ALL PROTECTIVE TAPES.
-  OPENING THE COVER OF THE DEVICE, TAKE OUT THE INSTRUCTION MANUAL.
-  PLACE THE DEVICES WITH ADJUSTABLE LEGS BY ADJUSTING THEIR LEGS AND THE DEVICE WITH FIXED LEGS BY ALIGNING THE GROUND.
-  CONNECT THE ELBOWED PART OF THE SUPPLY HOSE THE SOLENOID VALVE OF THE DEVICE, THE OTHER END, TO THE TAP.
-  CLAMP ONE END OF DRAINAGE HOSE TO THE DRAINAGE OUTLET OF THE MACHINE. CONNECT THE OTHER END OF IT TO SEWER SYSTEM COMING FROM THE GROUND.
-  DRAINAGE HOSE MUST NOT BE TWISTED, FOLDED, AND BENT MORE THAN 90°
-  SUPPLY WATER MUST BE AT 50°C IN TEMPERATURE AND 202 TO 404 KPA IN PRESSURE
-  IF THE CONNECTION TO SEWER SYSTEM ON THE GROUND IS ABOVE THE DRAINAGE OUTLET OF THE MACHINE, A DRAINAGE PUMP MUST BE USED.
-  IF THE WATER PRESSURE IS HIGHER THAN 404 KPA, A PRESSURE REDUCER VALVE MUST BE USED.
-  IF THE WATER PRESSURE IS LOWER THAN 202 KPA, A WATER PRESSURISING PUMP MUST BE USED.
-  SUPPLY WATER OF THE MACHINE MUST BE A 10 TO 15 ° FR. IF IT ISN'T, A WATER SOFTENING DEVICE MUST BE USED.
-  DRAINAGE LINE TO SEWER SYSTEM ON THE GROUND, WHICH DRAINAGE PIPE WAS CONNECTED TO, MUST HAVE A SIPHON, IN ORDER TO PREVENT BAD SMELLS.
-  REQUIRED VOLTAGE A WASHING MACHINE IS 380-400 AC V / 50 HZ.
-  MAKE A GROUNDING CONNECTION AND BE SURE THAT THIS CONNECTION HAS BEEN MADE CORRECTLY.
-  BE SURE THAT THERE IS ENERGY SUPPLY IN THE SYSTEM.
-  ON THE CONDITION THAT YOU HAVE FULFILLED ALL REQUIREMENT FOR OPERATING THE DEVICE, YOUR DEVICE IS READY FOR OPERATION.

## FINAL CHECK BEFORE START UP

- THE USERS SHOULD FULFIL THE FOLLOWING LAST-CONTROLS BY ACCEPTING THE REQUIRED COUPLINGS OF FRESH WATER, ELECTRIC, WASTEWATER , INSTALLATIONS TO BE CARRIED OUT BY THE AUTHORIZED TECHNICIANS;
- YOU MUST BE SURE THAT THE POWER SUPPLY AND GROUNDING INSTALLATION ARE ENSURED AS REQUIRED IN LEAFLETS OF ELECTRICAL EQUIPMENT.
- YOU MUST BE SURE THAT THE FEEDING WATER HAS BEEN INSTALLED AND THE WATER VANE IS TURNED ON.
- YOU MUST BE SURE THAT THE WASTEWATER INSTALLATION WAS DONE PROPERLY AND DISCHARGING HOSE WAS COUPLED WITH DISCHARGING PIPE TIGHTLY.



## II. START UP



HAVE A SPECIALIST ELECTRICIAN YOUR DEVICE WORKING 380-400 V CONNECT TO THE K-AUTOMAT FUSES GROUP.



DEVICE MUST NOT BE OPERATED WITHOUT BEING MADE ADEQUATE GROUNDING AND FROM THE ELECTRICITY SOURCE, WHICH DO NOT HAVE LEAK CURRENT RELAY.



WATER SUPPLY CONNECTION MUST BE MADE AND ITS VALVE MUST BE OPEN



WATER DRAINAGE CONNECTION MUST BE MADE.



BEFORE PLACING THINGS INTO THE BASKETS, SOLID WASTES MUST BE CLEANED AND SUBJECTED TO PRE-WASHING BY WASHING BUTTERY WITH SPRAYER.



DO NOT PLACE MORE DIRTY GLASSES THAN STATED IN THE TABLE INTO THE BASKET.



DO NOT USE ANY DETERGENT FOR PRE-WASHING.



KEEP THE VERY DIRTY DISHES (WAITING ONES MORE THAN 2-3 HOUR) UNDER WATER UNTIL COMPLETE DISSOLVING



DO NOT WASH MATERIALS MADE OF PLASTIC.



USE FOAM CONTROLLED LIQUID DETERGENT IN YOUR MACHINE.



HAVE THE DETERGENT FIRM DOSING APPARATUS TO SUPPLY DETERGENT INTO YOUR MACHINE CONNECT.



HAVE THE DETERGENT FIRM DOSING APPARATUS TO SUPPLY POLISHER INTO YOUR MACHINE CONNECT.



CHECK THE WATER SUPPLY HOSE AND WATER DRAINAGE CONNECTION.



FIX OVERFLOW PIPE INTO ITS PLACE.



OPEN THE VALVE OF PRESSURED HOT WATER SUPPLY.



PLACE THE BASKET, IN WHICH YOU PLACE THE THINGS TO BE WASHED, IN MACHINE.



CLOSE THE COVER OF THE DEVICE.



PRESS THE ON/OFF SWITCH (A). THE MACHINE TAKES THE WATER INSIDE AND BEGINS HEATING THE WATER. THE WATER TEMPERATURE INDICATORY LAMP (B) TURNS ON WHEN WATER TEMPERATURE IS READY.



WAIT UNTIL THIS LAMP (B) TURNS ON.



PRESS THE CYCLE START PUSH BUTTON (C) . THE MACHINE WILL START THE WASHING CYCLE.



THE WASHING KEEPS PROCEEDING WHILE "IT'S WASHING" LAMP (C) KEEP TURNED ON AND THE LAMP (C) WILL TURNED OFF AFTER THE WASHING CYCLE COMPLETES.



AFTER A WORKING DAY, TO DRAIN THE WATER MANUALLY FROM MACHINE; (ONLY FOR THE MACHINES WITH DRAIN PUMP)

- TURN OFF THE MACHINE BY PRESSING ON/OFF SWITCH(A)
- OPEN THE DOOR
- TAKE OFF THE DRAIN PIPE AND KEEP THE DOOR OPEN.
- AND PRESS DRAIN PUMP SWITCH (IT CAN ONLY BE SEEN WITH THE MACHINES WITH DRAIN PUMP). DURING YOU KEEP PRESSING THE SWITCH. THE MACHINE WILL DRAIN THE WATER FROM THE MACHINE MANUALLY.



WASHING TIME: I. PROGRAMME : 120 SEC

# CONTROL PANEL

FULL AUTOMATIC WASHING CYCLE AT 55 C WITH A CHOICE OF THREE DIFFERENT PROGRAMS FROM 1 TO 2 MINUTES.

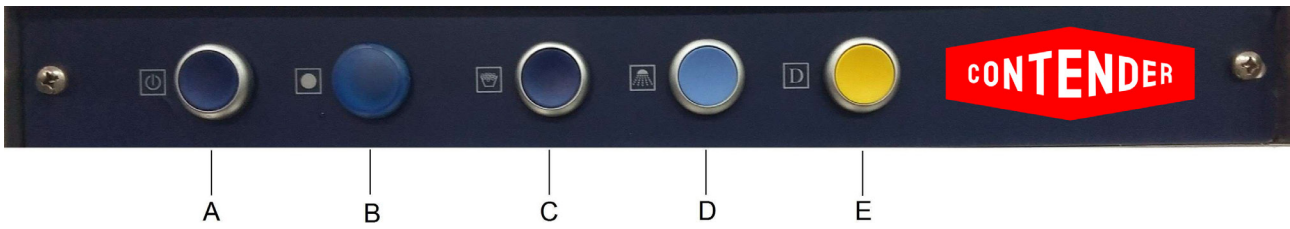

- A: MAIN SWITCH (CO-I)                      C: PROGRAM START BUTTON                      E: DRAIN PUMP START BUTTON
- B: WATER READY SIGNAL LAMP              D: MANUAL RINSE PUSH BUTTON

## 12. ELECTRIC DIAGRAM

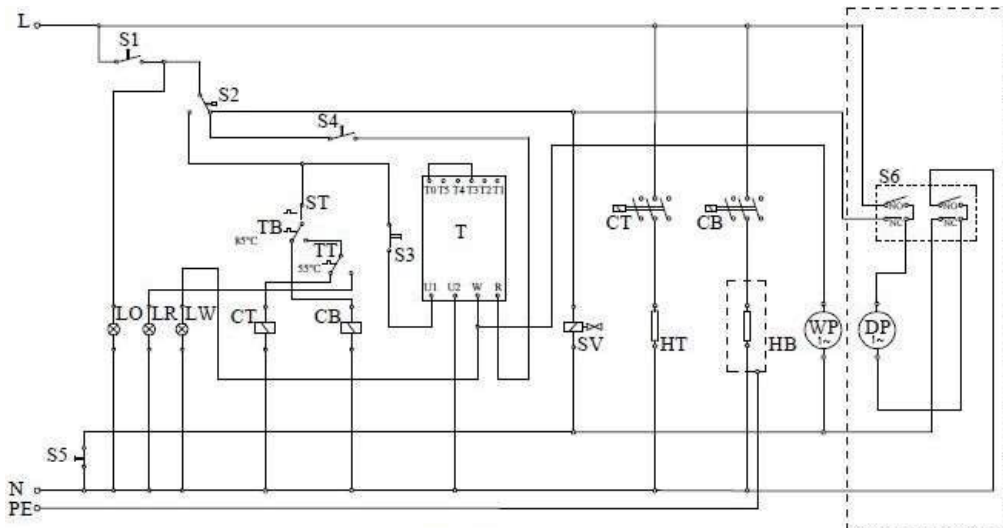



- |    |                        |    |                        |
|----|------------------------|----|------------------------|
| SL | ON/OFF SWITCH          | CB | BOILER CONTACTOR (15A) |
| S2 | PRESSURE SWITCH        | CT | TANK CONTACTOR (9A)    |
| S3 | PROGRAMME START BUTTON | HB | BOILER HEATER (3000V)  |
| S4 | MANUAL RINSE BUTTON    | HT | TANK HEATER (1800V)    |
| S5 | LID SWITCH             | WP | WASHING PUMP (0,25HP)  |
| S6 | DRAIN PUMP BUTTON      | DP | DRAIN PUMP             |
| ST | LIMIT THERMOSTAT       | SV | SOLENOID VALVE         |
| IB | BOILER THERMOSTAT      | LO | ON/OFF LAMP            |
| TI | TANK THERMOSTAT        | LR | WATER READY LAMP       |
| T  | TIMER                  | LW | WASHING LAMP           |













# 13. MAINTENANCE AND CLEANING

IMPLEMENT THE FOLLOWING PERIODICAL MAINTENANCE SO THAT THE PRODUCT SHOULD WORK IN SAFE AND LONG LIFE:



## DAILY MAINTENANCE











-  WHEN THE WATER IN WASHING TANK GETS DIRTY, IT MUST BE REPLACED BY FRESH WATER. FOR THIS PURPOSE, BRING THE “O-I” SWITCH OF THE MACHINE INTO “O” POSITION AND CLOSE THE DEVICE.
-  SWITCH OFF THE ELECTRICITY, SWITCHING OFF THE SWITCH.
-  OPENING THE COVER OF THE DEVICE, SPONGE THE SOLID WASTES IN THE DEVICE

## CLEANING THE DEVICE

-  WHEN THE WATER IN WASHING TANK GETS DIRTY, IT MUST BE REPLACED BY FRESH WATER.
-  FOR THIS PROPOSE, BRING THE STAND BY AND START SWATCHES OF THE MACHINE INTO “STOP” AND CLOSE THE DEVICE.
-  CLOSING THE SWITCH, SWITCH THE ELECTRICITY OFF.
-  AFTER OPENING THE COVER, BE CAREFUL OF NOT IMPACTING THE COVER HOLDER.
-  TAKE OUT THE OVERFLOW PIPE.
-  REMOVE THE WASHING AND RINSING BUTTERY NOZZLES AND CLEAN THEM. WASH THE RINSING NOZZLES AND RINSE THEM.
-  TAKING OUT THE SURFACE FILTERS AND PUMP SUCTION FILTERS, CLEAN THEM BY BRUSH UNDER THE FLOWING WATER.
-  FIX ALL PARTS IN THEIR PLACE IN SUCH A WAY CONFORMING TO THEIR ORIGINAL CONDITIONS.
-  CLOSE THE COVER OF THE DEVICE.
-  OPEN THE RELEVANT SWITCH ON THE CONTROL PANEL SUPPLYING ELECTRIC TO THE DEVICE. BRING THE “STAND BY” AND “START” SWITCHES INTO STARTING POSITION.
-  FOR COMPLETE CLEANING OF THE DEVICE, RUN THE DEVICE FOR 5 MINUTES
-  BRING THE “START” SWITCH INTO” PAUSE” POSITION.
-  OPEN THE COVER.

## WEEKLY MAINTENANCE

-  WHEN THE WATER IN WASHING TANK GETS DIRTY, IT MUST BE REPLACED BY FRESH WATER.
-  FOR THIS PURPOSE, BRING THE STAND BY AND START SWATCHES OF THE MACHINE INTO “STOP” AND CLOSE THE DEVICE.
-  CLOSING THE SWITCH, SWITCH THE ELECTRICITY OFF.

-  AFTER OPENING THE COVER, BE CAREFUL OF NOT IMPACTING THE COVER HOLDER.
-  TAKE OUT THE OVERFLOW PIPE.
-  REMOVE THE WASHING AND RINSING BUTTERY NOZZLES AND CLEAN THEM. WASH THE RINSING NOZZLES AND RINSE THEM.
-  TAKING OUT THE SURFACE FILTERS AND PUMP SUCTION FILTERS, CLEAN THEM BY BRUSH UNDER THE FLOWING WATER.
-  FIX ALL PARTS IN THEIR PLACE IN SUCH A WAY CONFORMING TO THEIR ORIGINAL CONDITIONS.
-  CLOSE THE COVER OF THE DEVICE.
-  OPEN THE RELEVANT SWITCH ON THE CONTROL PANEL SUPPLYING ELECTRIC TO THE DEVICE. BRING THE “STAND BY AND “START” SWITCHES INTO STARTING POSITION.
-  FOR COMPLETE CLEANING OF THE DEVICE, RUN THE DEVICE FOR 5 MINUTES
-  BRING THE “START” SWITCH INTO” PAUSE” POSITION.
-  OPEN THE COVER.

## 14. SAFE LIFE

THE SAFE LIFE OF THE PRODUCT IS 5 YEARS.

## 15. INTERVENTION AFTER

### FAILURES / CAUSES

- **DEVICE IS NOT WORKING**
  - CHECK WHETHER THERE IS ELECTRIC SUPPLY TO THE DEVICE.
  - BE SURE THAT THERE IS ELECTRIC SUPPLY TO THE STAND BY AND START SWITCHES
  - BE SURE THAT ELECTRIC SUPPLY TO LEVEL SWITCH AND SOLENOID VALVE.
- **THERE IS NO BEING FILLED:**
  - CHECK THE LEVEL SWITCH.
  - CHECK WHETHER THERE ARE ANY CONTAMINANTS IN THE TUBE IN WASHING TANK
  - BE SURE THAT THERE IS ADEQUATE LEVEL OF WATER IN WASHING TANK.
  - CHECK THE SOLENOID VALVE OPENS AND CLOSES. OPEN AND CLOSE THE SWITCH. IF IT DOES NOT WORK, CHANGE BY NEW ONES.
- **WASHING TANK IS NOT BEING FILLED OR THERE IS NO RINSING:**
  - BE SURE THAT THE TAP SUPPLYING WATER IS OPEN
  - CHECK WHETHER DRAINAGE PIPE IS FIXED IN ITS PLACE OR NOT.
  - BE SURE THAT STAND BY AND START SWITCHES ARE OPEN.
  - BE SURE THAT MAIN FUSE SUPPLYING THE MACHINE IS IN ACTIVE.
  - CHECK THE FUSE OF MACHINE.
  - BE SURE THAT THERE IS NO PLUGGING IN BUTTERY NOZZLES DUE TO CONTAMINANTS.
  - BE SURE THAT SUFFICIENT AMOUNT OF AIR IN AIR HOUSING
  - TAKE OUT THE OVERFLOW PIPE AND EMPTY THE TANK COMPLETELY.
  - IF THIS IS NOT A SOLUTION FOR THE PROBLEM, CHANGE THE LEVEL SWITCH.
  - OPENING AND CLOSING THE STAND BY SWITCH, CHECK THE SOLENOID VALVE. IF IT DOES NOT WORK, CHANGE IT BY NEW ONE.



- **WASHING TANK IS SLOWLY BEING FILLED:**
  - BE SURE THAT THE TAP SUPPLYING WATER IS OPEN.
  - CHECK THE WATER PRESSURE, IF IT IS LOWER THAN 202 KPA, USE THE PRESSURIZING PUMP.
  - REMOVE THE WATER SUPPLYING HOSE. TAKE APART THE FILTER OF SOLENOID VALVE AND CLEAN IT
  - BE SURE THAT RINSING NOZZLES ARE NOT PLUGGED
  - BE SURE THAT OVERFLOW PIPE COMPLETELY SITS IN ITS HOUSING. IF THERE IS PRESSURE REDUCING VALVE, TAKE IT OUT.
  
- **MACHINE IS NOT HEATING WASHING AND RINSING WATER:**
  - AFTER CHECKING THAT OVERFLOW PIPE IS CONNECTED TO ITS PLACE, BE FILLED THE WASHING TANK.
  - CHECK WHETHER OR NOT THE THERMOSTAT OF RINSING WATER BOILER IS SET TO 80 °C, AND THE THERMOSTAT OF WASHING WATER, TO 50°C
  - CHECK THE CABLES AND THEIR CONNECTIONS.
  
- **WASHING TANK IS NOT BEING EMPTIED:**
  - WASHING TANK CAN NOT BE EMPTIED DUE TO SOLID WASTES. INSPECT THE WATER DRAINAGE HOSE FROM OVERFLOW PIPE TO SIPHON ON THE GROUND. BE SURE THAT IT IS CLEAN.
  
- **MACHINE IS NOT EFFICIENTLY WORKING:**
  - BE SURE THAT PUMP SUCTION FILTER IS CLEAN
  - BE SURE THAT THE NOZZLES OF WASHING BUTTERY ARE CLEAN
  - BE SURE THAT ADEQUATE AMOUNT OF DETERGENT IS DELIVERED TO THE MACHINE.
  - SELECTED WASHING PROGRAM IS VERY SHORT DUE TO THE FACT THAT THE POTS ARE DIRTY
  - SELECT THE LONGER PROGRAM AND RUN AGAIN THE MACHINE.
  - CHECK WHETHER WATER TEMPERATURE IN WASHING TANK IS CORRECT OR NOT.
  
- **THERE IS NO DRYING: (MODELS WITH DRYING SYSTEM)**
  - BE SURE THAT THE AMOUNT OF POLISHER INJECTED TO THE MACHINE IS CORRECT
  - CHECK THE THERMOSTAT OF RINSING WATER IS SET TO 80 °C.
  
- **CONDENSATION IN THE GLASSES.**
  - DO NOT STORE THE GLASSES ON A FLAT SURFACE.
  - THE AMOUNT OF DOSED POLISHER IS NOT CORRECT.
  - THE AMOUNT OF DOSED POLISHER IS NOT CORRECT.
  
- **STRIPED GLASSES:**
  - USE ONLY FOAMLESS DETERGENT.
  
- **THERE IS AN EXCESS AMOUNT OF FOAM IN THE WASHING TANK:**
  - WATER TEMPERATURE IN WASHING TANK MUST NOT BE LOWER THAN 50°C.
  - CHECK THE DETERGENT AND POLISHER DOSING APPARATUS. THERE CAN BE EXCESSIVE DOSING
  - BE SURE THAT MACHINE WAS MOT CLEANED BY FOAMED DETERGENT. EMPTY THE TANK AND BOILER.
  - IF FOAMED DETERGENT WAS USED, EMPTY THE TANK AND BE FILLED IT BY FRESH WATER. CONTINUE TO MAKE THIS OPERATION UNTIL THE FOAM DISAPPEAR.
  
- **THERE IS STAIN ON THE GLASS :**
  - DECREASE THE AMOUNT OF DOSED POLISHER.
  - ACCEPTABLE DOSAGE IS 0,1 CC / LITRE WATER.
  
- **THE ARMS OF WASHING BUTTERY ARE NOT CORRECTLY ROTATING:**
  - REMOVE THE WASHING ARM AND CLEAN IT.
  - BE SURE THAT WATER PRESSURE IS MORE THAN 202 KPA, IF THE PRESSURE IS LOWER, MOUNT A PRESSURISING PUMP.

# 16. SPARE PARTS LIST

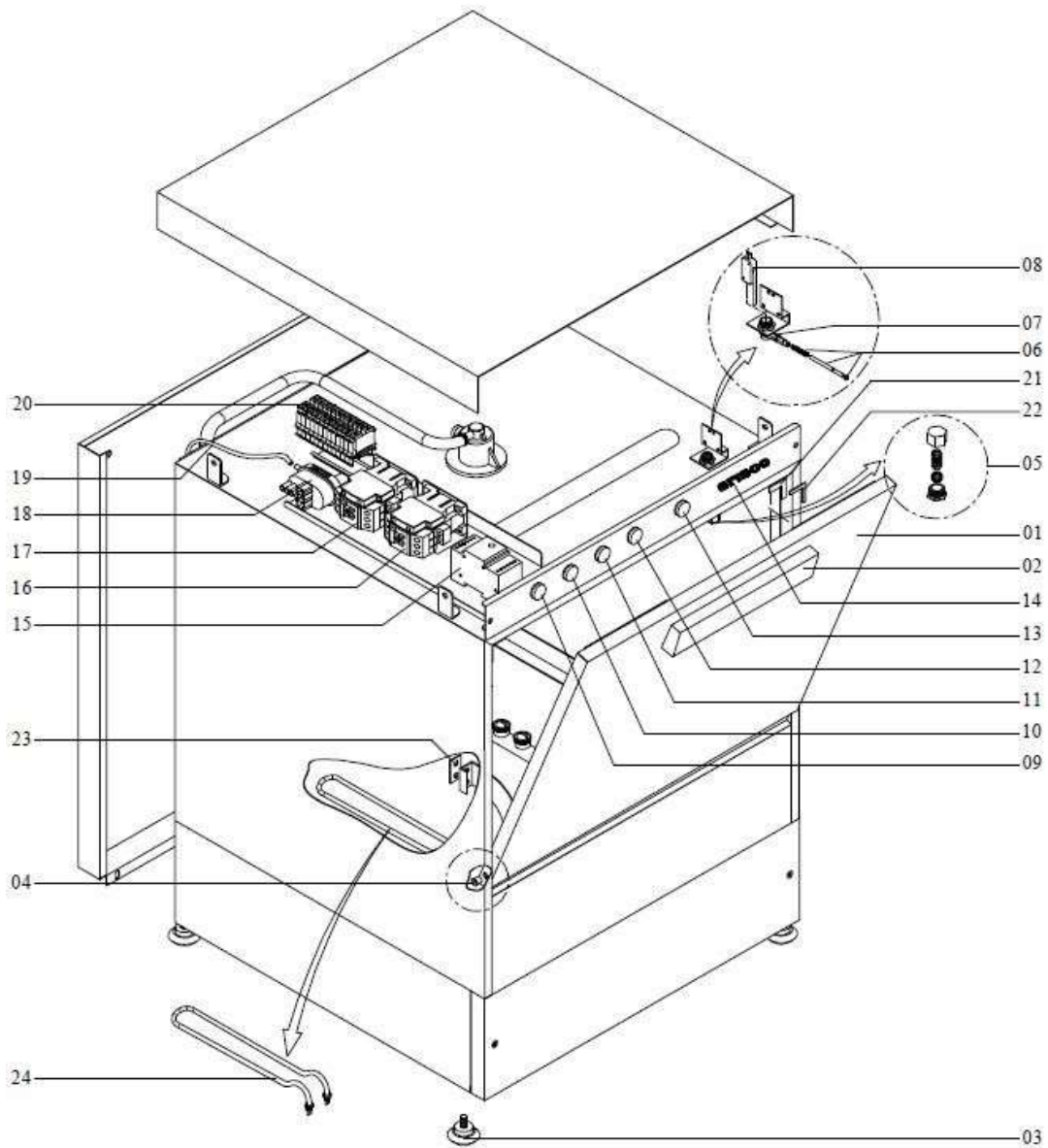

NO	DESCRIPTION	NO	DESCRIPTION
01	Door	13	Signal Lamp
02	Handle	14	Panel Label
03	Foot	15	Timer
04	Door pin & Bearing	16	Boiler Contactor
05	Door Lock	17	Tank Contactor
06	Switch pin	18	Pressure Switch
07	Door switch housing	19	Pipe for pressure switch
08	Door Switch	20	Connectors
09	On/Off Switch	21	Corner Plastic
10	Signal Lamp	22	Corner Rubber
11	Signal Lamp	23	Door Stop
12	Signal Lamp	24	Heating Element

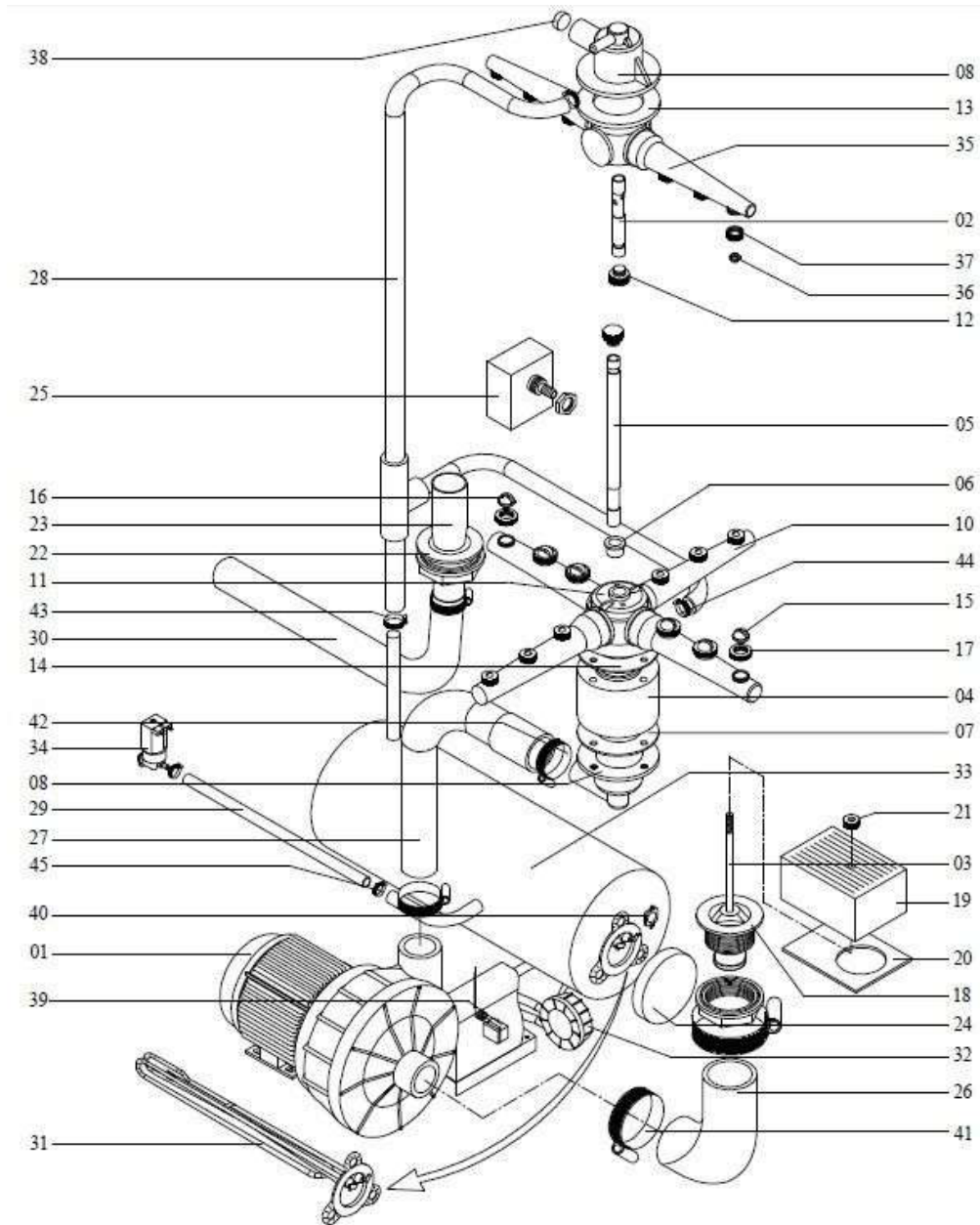

NO	DESCRIPTION	NO	DESCRIPTION	NO	DESCRIPTION
01	Wash Pump	16	Nozzle	31	Heating Element Boiler
02	Shaft	17	Nut	32	Rinse aic Dispenser
03	Suction Filter Pin	18	Flange	33	Boiler
04	Amplifier	19	Suction Filter	34	Solenoid Valve
05	Shaft	20	Suction Filter Bottom	35	Rinse Arm
06	Bearing	21	Nut	36	Nozzle
07	Gasket	22	Drainer	37	Nut
08	Body	23	Drain Pipe	38	Plug
08	Body	24	Lid	39	Thermostat
10	Arm	25	Pressure Pot	40	Limiter
11	Terminal	26	Hose	41	Clip
12	Bolt	27	Hose	42	Clip
13	Flange	28	Hose	43	Clip
14	Flange	29	Hose	44	Clip
15	Nozzle	30	Hose	45	Clip











**CONTENDER PRO400 COMMERCIAL GLASSWASHER · SKU: DMG005**



**STEP UP TO THE PLATE**

**DISTRIBUTED BY RG DISTRIBUTORS LTD. TEL: 0333 358 3678**