

# CONTENDER

STEP UP TO THE PLATE

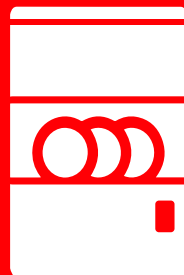

## CONTENDER PASS THROUGH HOOD DISHWASHER

DMH001 – CONTENDER PASS-THROUGH HOOD DISHWASHER SINGLE PHASE

DMH002 – CONTENDER PASS-THROUGH HOOD DISHWASHER 3 PHASE ELECTRIC

# CONTENTS

I.	AIMS AND SCOPE.....	4
2.	RESPONSIBILITIES .....	4
3.	SIGNS .....	4
4.	TECHNICAL DATA (BASIC FEATURES) .....	5
5.	TRANSPORTATION AND INSTALLATION .....	7
6.	GENERAL PRINCIPLES.....	6
7.	PACKAGE CONTENTS .....	8
8.	DESCRIPTION OF DEVICE WITH EXPLANATIONS .....	9
9.	COMPLIANCE .....	10
10.	REPLACING THE DEVICE AND PREPARING FOR START UP .....	10
	INSTALLATION BEFORE ASSEMBLING	
	PREPARATION FOR START UP	
	FINAL CHECK BEFORE START UP	
II.	START UP .....	12
12.	ELECTRICAL DIAGRAM.....	14
13.	MAINTENANCE AND CLEANING DAILY .....	14
	MAINTENANCE AND CLEANING	
	WEEKLY MAINTENANCE AND CLEANING	
14.	SAFE LIFE .....	16
15.	INTERVENTION AFTER FAILURE.....	16
16.	SPARE PARTS LIST .....	18



# I. AIMS AND SCOPE





DESCRIPTIONS FOR SAFE USE AND MAINTENANCE OF THE PRODUCT



## 2. RESPONSIBILITIES

**RESPONSIBILITIES OF PRODUCT OWNER:** THE PRODUCT'S OWNER IS RESPONSIBLE FOR APPLYING OF SAFETY RULES STATED IN THIS INSTRUCTION MANUAL OR GETTING THEM APPLIED BY DELEGATING HIS AUTHORITIES AND RISKS, WHICH MAY ARISE DUE TO NOT APPLYING. THE PRODUCT'S OWNER IS ALSO RESPONSIBLE FOR THE PERIODICAL MAINTENANCE OF THE MACHINE.

**RESPONSIBILITIES OF THE MANUFACTURER:** THE MANUFACTURER IS RESPONSIBLE FOR THE RISKS DUE TO MANUFACTURING AND ASSEMBLING FAULTS, EVEN THOUGH ALL REQUIREMENTS STATED IN THIS MANUAL HAVE BEEN FULFILLED.

## 3. SIGNS

	<b>WARNING:</b> THIS SIGN INDICATES THAT IT MUST BE COMPLIED WITH THE INSTRUCTIONS RELATED TO THE SUBJECT; OTHERWISE, THE RISKY CONDITIONS, IN WHICH THERE CAN OCCUR SOME DAMAGES AND DANGERS
	<b>CAUTION:</b> THIS SIGN INDICATES ANY RISKY CONDITIONS, WHICH CAN CAUSE DAMAGES IN MATERIAL AND INJURING OF PEOPLE, PROVIDED THAT ONE DOES NOT PAY ATTENTION AND STATES THAT ONE MUST BE CAREFUL
	<b>DANGER:</b> THIS SIGN INDICATES HIGH RISKY CONDITIONS IN WHICH PEOPLE CAN BE INJURED, PROVIDED THAT ONE DOES NOT PAY ATTENTION AND THE RULES ALWAYS TO BE COMPLIED WITH.
	<b>DANGER:</b> THIS SIGN INDICATES HIGH RISKY CONDITIONS IN WHICH THE PEOPLE CAN BE INJURED OR CAN DIE DUE TO ELECTRICAL SHOCK.
	<b>EQUIPOTENTIAL CONNECTION TERMINAL</b> (IF NECESSARY, IT MUST BE CONNECTED TO OTHER EQUIPMENT TO MAKE EQUAL THE POTENTIAL)

<b>A</b>				
<b>B</b>	Mod:	SN:		<b>F</b>
<b>C</b>	Volt:	Gas: gr	Class:	
<b>D</b>	P(H <sub>2</sub> O) = ( )x10 <sup>1</sup> kPa ( Bar)	MADE IN  		<b>G - H</b>
<b>E</b>	Kw:	IPX	TURKEY	
	<b>J</b>	<b>K</b>	<b>L</b>	<b>M</b>

- A** COMPANY INFORMATION
- B** MODEL
- C** ENERGY
- D** PRESSURE
- E** POWER
- F** SERIAL NUMBER\*
- G** CONSUMPTED GAS AND AMOUNT

- H** CLASS
- J** IP CLASS
- K** PRODUCTION LOCATION
- L** CE SIGN
- M** WEEE SIGN

\* FIRST THREE NUMBERS ARE GROUP CODES. 4TH AND 5TH NUMBERS ARE YEAR OF PRODUCTION. 6TH & 7TH NUMBERS ARE THE MONTH OF PRODUCTION. 8TH, 9TH & 10TH NUMBERS ARE THE SERIAL NUMBER.

# 4. TECHNICAL DATA

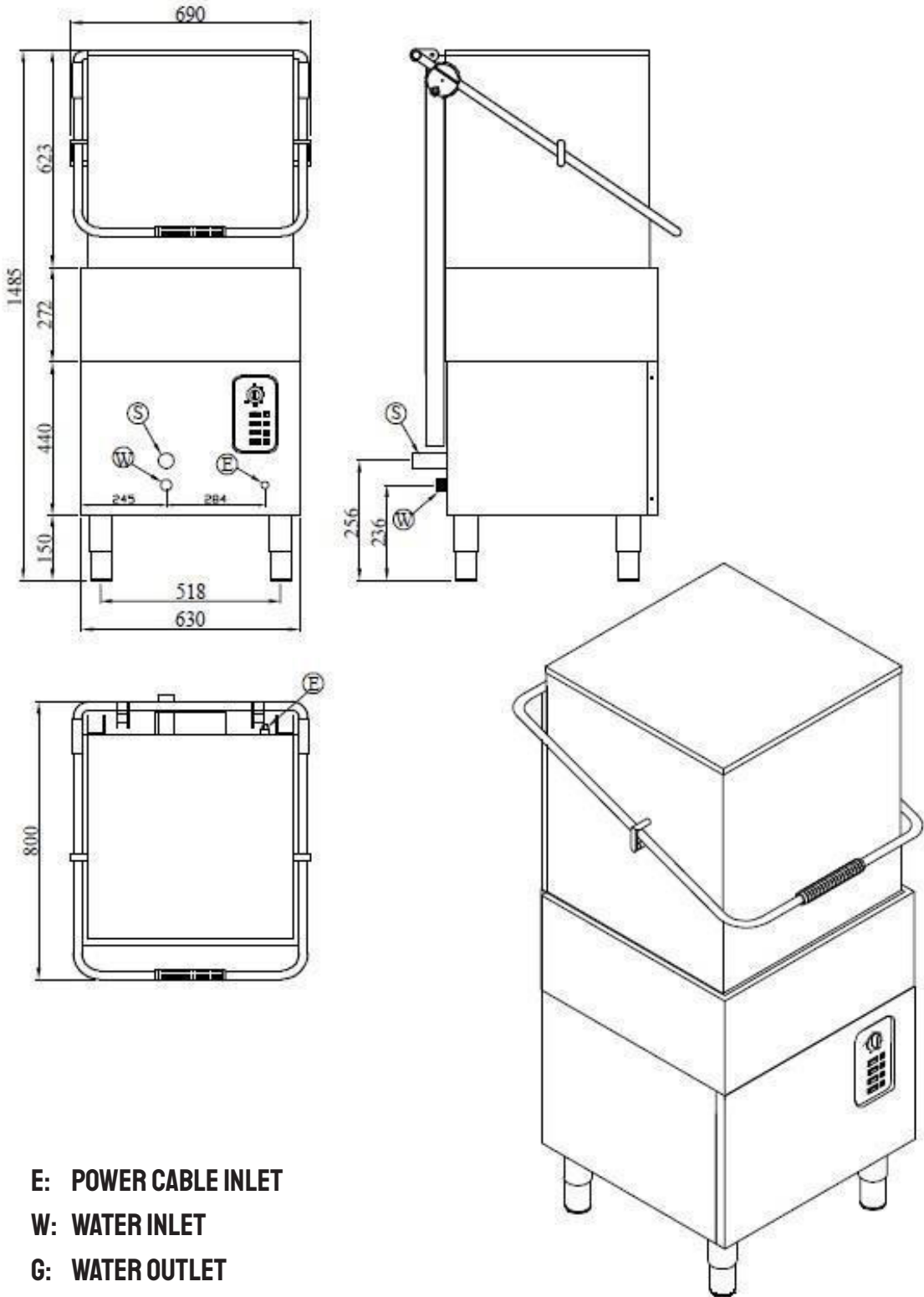





- E: POWER CABLE INLET**
- W: WATER INLET**
- G: WATER OUTLET**













## 4. TECHNICAL DATA

MODEL		DMH001 & DMH002	
<b>CAPACITY</b>			
PLATES		60'	1080
GLASSES			2880
<b>STANDARD SEPET</b>			
BASKET FOR 18 PLATES	50X50	N	2
GLASS-CUP BASKET	50X50	N	0
CUTLERY BASKET	50X50	N	1
<b>ELECTRIC</b>			
VOLTAGE		V	380-400 AC V, 3~, 50HZ
WASHING TANK HEATER		W	3000
RINSING WATER HEATER		W	9000
MAXIMUM POWER		W	13100
MAIN SUPPLY CABLE		MM <sup>2</sup>	5X2.5
<b>FEED WATER</b>			
WATER INLET PRESSURE		BAR	2-4
WATER HARDNESS		°FR	15
WATER INLET TEMPERATURE		°C	45-50
WATER INLET CONNECTOR DIAMETER		Ø	¾"
WATER INLET CONNECTOR DIAMETER DRAINAGE		ØMM	32
HEIGHT		CM	28
<b>WASHING</b>			
TEMPERATURE		°C	50-55
WASHING TANK CAPACITY		IT	60
WASHING PUMP WASHING		KW	1.10
DURATION			1040TP 1-3 MIN.
<b>RINSING</b>			
TEMPERATURE		°C	80-85
RINSING WATER CONSUMPTION		IT/BASKET	2,5
LENGTH		CM	72
WIDTH		CM	83
HEIGHT		CM	148
GROSS WEIGHT		KG	123
VOLUME		M <sup>3</sup>	1,06

## 5. TRANSPORT & INSTALLATION

	<b>DURING TRANSPORTATION, TAKE NECESSARY PRECAUTIONS AGAINST THE RISK OF THE PRODUCT FALLING DOWN AND BEING TURNED UPSIDE DOWN.</b>
	<b>PLACE THE PRODUCT ONTO A FLAT AND SOLID GROUND.</b>
	<b>DO NOT INSTALL THE PRODUCT NEAR THE FLAMMABLE AND EXPLOSIVE MATERIALS AND DO NOT KEEP ANY FLAMMABLE AND EXPLOSIVE MATERIAL NEAR THE FURNACE, WHILE IT IS WORKING.</b>
	<b>KEEP A FIRE EXTINGUISHER NEAR THE FURNACE AND CHECK WHETHER THE PERIODICAL CHECKING OF THE FIRE EXTINGUISHER HAS BEEN IMPLEMENTED OR NOT.</b>

## 6. GENERAL PRINCIPLES

-  **THE USERS AGREE AND ACCEPT TO BE IN CONFORMITY WITH ALL REQUIREMENTS INCLUDED IN USING MANUAL, OTHERWISE THE MACHINE SHALL BE DEEMED OUT OF GUARANTEE COVERAGE.**
-  **THE USER ALSO ACCEPTS THAT HE/SHE WAS FULLY INFORMED ABOUT THE LIMITED GUARANTEE LIABILITY.**
-  **ANY LIVING BODY OR ANY OBJECT SHOULD NOT BE PLACED ON MACHINES. IN ADDITION, ANY LIVING BODY SHOULD NOT BE PUT INSIDE THE MACHINES.**
-  **CHILDREN OR ANY OTHER UNAUTHORISED PERSONS SHOULD NOT BE ALLOWED THE TO OPERATE THE MACHINE.**
-  **ANY ELECTRICAL OPERATING MACHINES SHOULD BE CLEANED AFTER THE REQUIRED ELECTRICAL CONNECTIONS SWITCHED OFF.**
-  **THE ELECTRICAL PRODUCTS SHOULD NEVER BE OPERATED IF ANY SUFFICIENT GROUNDING INSTALLATION HAD NOT BEEN PRACTICED IN ADDITION; THE LEAK CURRENT RELAY AND FUSE GROUPS HAD NOT BEEN INSTALLED IN CONTROL BOX SUPPLYING THE ELECTRICAL ENERGY TO THE MACHINE.**
-  **THE COVER OF ANY MACHINE SHOULD NOT BE OPENED DURING THE PERIOD OF WORKING.**
-  **USE FOAM FREE AND FOAM CONTROLLED LIQUID DETERGENT AND POLISHER IN YOUR MACHINE. WHILE THE DEVICE IS WORKING, DO NOT OPEN IN ANY WAY THE COVER OF THE DEVICE WITH COVER.**
-  **BE CAREFUL NOT TO TRAP YOUR HANDS WHILE CLOSING THE COVERS.**
-  **THE MACHINES AND COVERS SHOULD NOT BE TREATED AS STEP OR LADDER IN ANY CASE.**
-  **THE ELECTRICAL DEVICES SHOULD NEVER BE WASHED IN THE MANNER OF SPRAYING WATER. THEY SHOULD BE CLEANED BY MEANS OF RUBBING AFTER SWITCHING THE POWER OFF THE POWER HAD BEEN SWITCHED OFF.**
-  **ANY SCRATCHIER OR STRIPPER TOOLS SHOULD NOT BE USED DURING THE CLEANING.**

- i** THIS MANUAL VERIFIES ALL MACHINES WERE TESTED AND THE REQUIRED SECURITY CONTROLS WERE DONE IN DUE DILIGENCE SO DELIVERED UNDER OPERATING CONDITIONS.
- i** DO NOT CONNECT THE DEVICES, WHICH ARE IN CONNECTION WITH HOSE, TO THE WATERLINES IN THE TEMPERATURES BELOW – 5°C AND ABOVE 50°C.
- i** USE RUBBER GLOVES DURING THE CLEANING AND MAINTENANCE PRACTICES PROCEDURES
- i** DO NOT REMOVE THE LABELS AND PANELS OF THE DEVICES.
- i** IN ORDER TO USE EFFICIENTLY AND TO DECREASE MINIMUM THE ENERGY EXPENSES, SUPPLY WATER IN 50°C TO YOUR DEVICES WITH AN ELECTRICAL HEATING SYSTEM. ADDITIONALLY, IN ORDER TO ELONGATE THE LIFE OF YOUR DEVICE, USE SURELY SOFT WATER IN 15 °F IF YOU DO NOT HAVE THE WATER IN THIS SOFTNESS, USE A WATER SOFTENING DEVICE.
- i** THE MANUFACTURER HAS THE RIGHT TO MAKE ALL CHANGES, WHICH HE/SHE DEEMS TO BE USEFUL FOR USER OR HIM/HER. HOWEVER, HE/SHE GUARANTEES THAT THE FEATURES RELATED TO PRIMARY FUNCTIONALITY AND SAFETY OF THE DEVICE WILL BE MAINTAINED.
- i** IN CASE OF ANY FAILURE, CUT THE ELECTRICAL AND WATER CONNECTION OF THE DEVICE OFF AND APPLY TO THE AUTHORISED SERVICES.
- i** IN YOUR DEVICE, DO NOT WASH THE THINGS SUCH AS POTS AND PANS, SAUCEPANS IN DIFFERENT AND BIG SIZES, WHICH DO NOT FIT TO USE PURPOSE.
- i** WHILE THE WATER IN THE BOILER OF YOUR DEVICE IS HOT, DO NOT INSERT YOUR HAND INTO THE BOILER. WATER THAT IS HOT AND CONTAINS DETERGENT CAN BE HARMFUL FOR YOUR SKIN. IN SUCH A CONDITION, RINSE YOUR HAND WITH WARM WATER.
- i** POWER CORD MUST BE MIN. H05RN-F TYPE.
- i** CABLE DIAMETER MUST BE MIN 5X2.5 MM2
- i** GROUNDING LINE MUST BE CONTINUOUSLY CHECKED.

## 7. PACKAGE CONTENTS

- DESCRIPTION CATALOGUE
- USER/MAINTENANCE/ASSEMBLING MANUAL
- WATER SUPPLYING HOSE
- DRAINAGE HOSE TO SEWER SYSTEM
- BASKET

DEAR CUSTOMERS, PLEASE CHECK THE ABOVE WRITTEN AUXILIARY EQUIPMENT TO BE GIVEN WITH THE MACHINE ON DELIVERY. IF YOU NOTICE ANY DAMAGE OR LOSS OCCURRED DURING THE TRANSPORTATION THEN YOU SHOULD REQUEST THE TRANSPORTER TO ISSUE ANY WRITTEN REPORT INCLUDING THE RELEVANT DAMAGE OR LOSS.

### UPON REQUEST:

- AUTOMATIC POLISHER FEEDING APPARATUS
- AUTOMATIC DETERGENT FEEDING APPARATUS
- WATER PUMP (IF THE WATER PRESSURE IS LOW)
- INLET/OUTLET COUNTERS



## 8. DESCRIPTION OF DEVICE WITH EXPLANATIONS

- THIS WASHING MACHINE HAS BEEN MANUFACTURED TO HYGIENIC STANDARDS.
- THE FRAME (INSIDE/OUTSIDE), INCLUDING CHASSIS, PANEL AND BOILER, HAS BEEN MANUFACTURED FROM STAINLESS STEEL MATERIAL.
- THE LEGS ARE IN ADJUSTABLE FEATURE AND MANUFACTURED FROM STAINLESS STEEL MATERIAL.
- WASHING TANK IS AUTOMATICALLY FILLED AND CONTINUOUS LEVEL CONTROLLED.
- WASHING AND RINSING WATER TEMPERATURES ARE AUTOMATICALLY CONTROLLED VIA TWO THERMOSTATS WORKING INDEPENDENTLY.
- PROGRAM DURATION CAN BE ADJUSTED BY MEANS OF TIMER AS FROM 1 TO 3 MINUTES FOR DMH001 & DMH002
- COVER IS OPENED UPWARD IN SIMILAR TO GUILLOTINE. ONCE THE COVER IS OPENED, DEVICE PASSES TO “STOP” POSITION. PROVIDED THAT IT IS CLOSED, PROGRAM CONTINUES TO WORK FROM THE PREVIOUS POINT.
- THE PUMPS HAVE BEEN MANUFACTURED AS DETERGENT AND HOT WATER RESISTANT.
- MOTORS HAVE A HEAT RESISTANT FEATURE AND ARE PROTECTED BY COOLING OF FAN AGAINST HIGHER TEMPERATURES.
- THE INSULATION OF BOILER HAS BEEN PROVIDED BY GLASS WOOL THAT IS A SPECIAL INSULATION MATERIAL. THUS, HEAT LOSSES CAN BE REDUCED TO MINIMUM LEVEL AND PREVENTED THE WASTING OF ENERGY AS WELL.
- THE SYSTEM HAS BEEN FULLY SECURED BY MEANS OF THERMAL AND ELECTRICAL PROTECTORS. ACCESS TO ELECTRICAL PANEL, EXECUTING OF MAINTENANCE WORKS AND INSPECTIONS HAVE BEEN QUITE FACILITATED.
- FULL AUTOMATICALLY WASHING HAS BEEN PERFORMED AT 55 °C.
- RINSING IS PERFORMED AT 80 TO 85 °C BY HOT AND FRESH WATER.
- ELECTRICAL EQUIPMENT AND CABLES COMPLY WITH EUROPEAN STANDARDS AND SAFETY REGULATIONS.

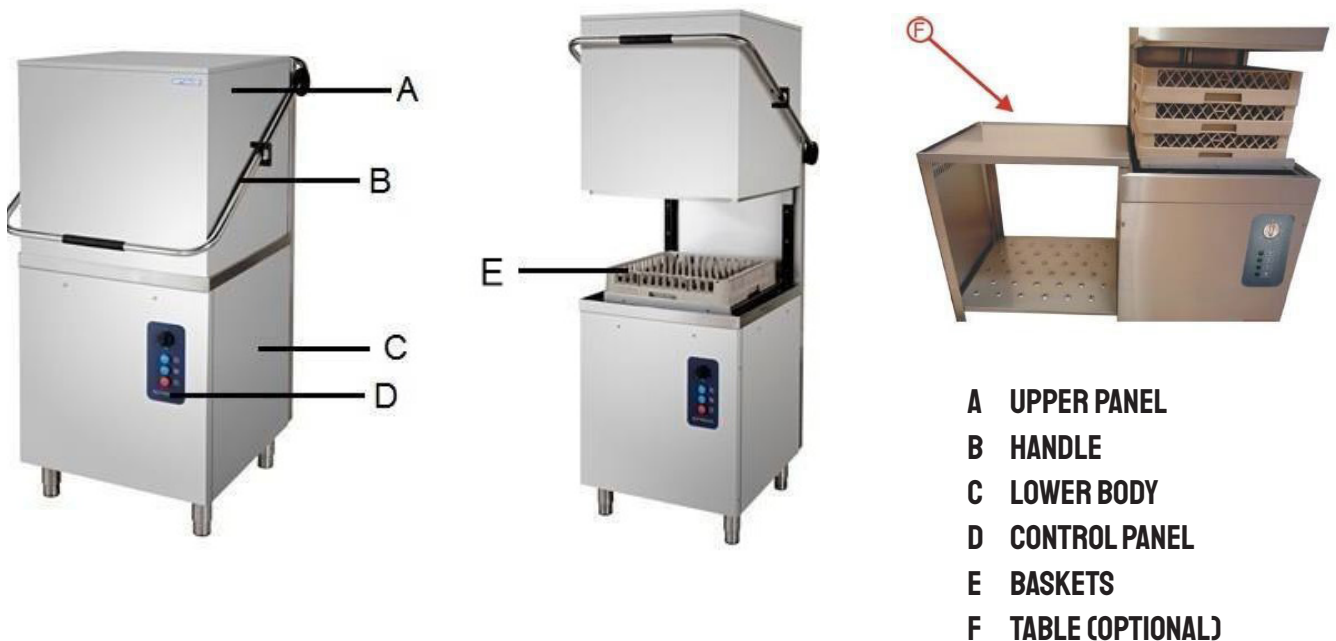

# 9. COMPLIANCE

THESE PRODUCTS ARE CE CERTIFIED AND ARE IN COMPLIANCE WITH THE FOLLOWING DIRECTIVES:

2014/35/EU  
LOW VOLTAGE DIRECTIVE (AS AMENDED)

LVD: EN 60335-1: 2012/All:2014  
EN 60335-2-5: 2015





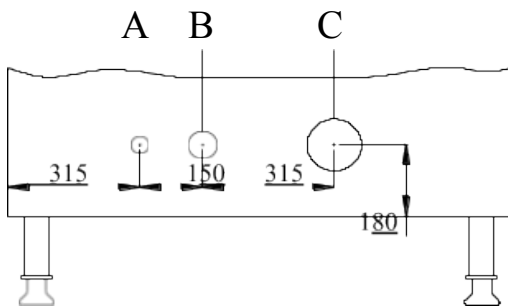



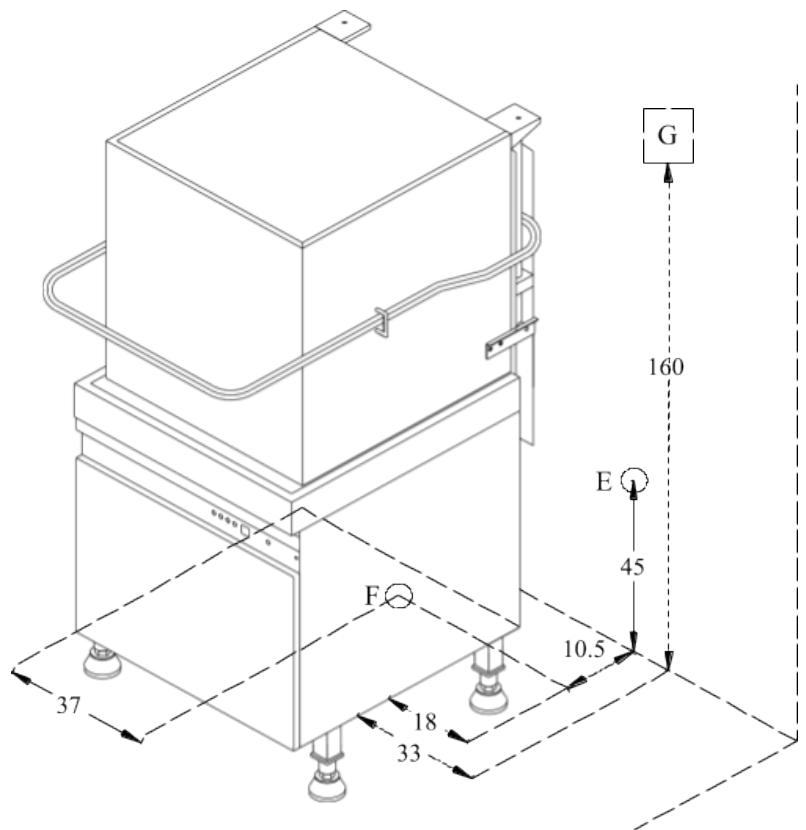









# 10. REPLACING THE DEVICE AND PREPARING FOR START UP INSTALLATION BEFORE ASSEMBLING



	DESCRIPTION
A	FRESH WATER INLET
B	POWER CORD INLET
C	DIRTY WATER OUTLET
D	CONNECTION OF THE MACHINE TO GROUNDING LINE
E	TAP WITH CONNECTOR TO SUPPLY THE PRESSURED (202 – 404 KPA) AND HOT WATER (45-50 °C). (IF THE WATER HARDNESS IS HIGHER THAN 10 - 15°F, SOFTENING WATER DEVICE MUST BE USED.)
F	DIRTY WATER DRAINAGE IN 50 MM OF DIAMETER, WHICH DIRTY WATER HOSE WILL BE CONNECTED TO. (ON THE GROUND AND BELOW THE MACHINE, AND NEXT TO THE BACK WALL.)
G	380 V 3X25 A. K – AUTOMAT FUSE GROUP TO MEET THE REQUIREMENT OF THE DEVICE.



















## PREPARATION FOR START UP

-  OPEN THE PACKING OF THE DEVICE AND REMOVE ALL PROTECTIVE TAPES.
-  OPENING THE COVER OF THE DEVICE, TAKE OUT THE INSTRUCTION MANUAL.
-  PLACE THE DEVICES WITH ADJUSTABLE LEGS BY ADJUSTING THEIR LEGS AND THE DEVICE WITH FIXED LEGS BY ALIGNING THE GROUND.
-  CONNECT THE ELBOWED PART OF THE SUPPLY HOSE THE SOLENOID VALVE OF THE DEVICE, THE OTHER END, TO THE TAP.
-  CLAMP ONE END OF DRAINAGE HOSE TO THE DRAINAGE OUTLET OF THE MACHINE. CONNECT THE OTHER END OF IT TO SEWER SYSTEM COMING FROM THE GROUND.
-  DRAINAGE HOSE MUST NOT BE TWISTED, FOLDED, AND BENT MORE THAN 90°
-  SUPPLY WATER MUST BE AT 50°C IN TEMPERATURE AND 202 TO 404 KPA IN PRESSURE
-  IF THE CONNECTION TO SEWER SYSTEM ON THE GROUND IS ABOVE THE DRAINAGE OUTLET OF THE MACHINE, A DRAINAGE PUMP MUST BE USED.
-  IF THE WATER PRESSURE IS HIGHER THAN 404 KPA, A PRESSURE REDUCER VALVE MUST BE USED.
-  IF THE WATER PRESSURE IS LOWER THAN 202 KPA, A WATER PRESSURISING PUMP MUST BE USED.
-  SUPPLY WATER OF THE MACHINE MUST BE A 10 TO 15 ° FR. IF IT ISN'T, A WATER SOFTENING DEVICE MUST BE USED.
-  DRAINAGE LINE TO SEWER SYSTEM ON THE GROUND, WHICH DRAINAGE PIPE WAS CONNECTED TO, MUST HAVE A SIPHON, IN ORDER TO PREVENT BAD SMELLS.
-  REQUIRED VOLTAGE A WASHING MACHINE IS 380-400 AC V / 50 HZ.
-  MAKE A GROUNDING CONNECTION AND BE SURE THAT THIS CONNECTION HAS BEEN MADE CORRECTLY.
-  BE SURE THAT THERE IS ENERGY SUPPLY IN THE SYSTEM.
-  ON THE CONDITION THAT YOU HAVE FULFILLED ALL REQUIREMENT FOR OPERATING THE DEVICE, YOUR DEVICE IS READY FOR OPERATION.





## FINAL CHECK BEFORE START UP

- THE USERS SHOULD FULFIL THE FOLLOWING LAST-CONTROLS BY ACCEPTING THE REQUIRED COUPLINGS OF FRESH WATER, ELECTRIC, WASTEWATER , INSTALLATIONS TO BE CARRIED OUT BY THE AUTHORIZED TECHNICIANS;
- YOU MUST BE SURE THAT THE POWER SUPPLY AND GROUNDING INSTALLATION ARE ENSURED AS REQUIRED IN LEAFLETS OF ELECTRICAL EQUIPMENT.
- YOU MUST BE SURE THAT THE FEEDING WATER HAS BEEN INSTALLED AND THE WATER VANE IS TURNED ON.
- YOU MUST BE SURE THAT THE WASTEWATER INSTALLATION WAS DONE PROPERLY AND DISCHARGING HOSE WAS COUPLED WITH DISCHARGING PIPE TIGHTLY.

## II. START UP

-  HAVE A SPECIALIST ELECTRICIAN YOUR DEVICE WORKING 380-400 V CONNECT TO THE K-AUTOMAT FUSES GROUP.
-  DEVICE MUST NOT BE OPERATED WITHOUT BEING MADE ADEQUATE GROUNDING AND FROM THE ELECTRICITY SOURCE, WHICH DO NOT HAVE LEAK CURRENT RELAY.
-  WATER SUPPLY CONNECTION MUST BE MADE AND ITS VALVE MUST BE OPEN
-  WATER DRAINAGE CONNECTION MUST BE MADE.
-  BEFORE PLACING THINGS INTO THE BASKETS, SOLID WASTES MUST BE CLEANED AND SUBJECTED TO PRE-WASHING BY WASHING BUTTERY WITH SPRAYER.
-  DO NOT PLACE MORE DIRTY DISHES THAN STATED IN THE TABLE INTO BASKETS.
-  DO NOT USE ANY DETERGENT FOR PRE-WASHING.
-  KEEP THE VERY DIRTY DISHES (WAITING ONES MORE THAN 2-3 HOUR) UNDER WATER UNTIL COMPLETE DISSOLVING
-  DO NOT WASH MATERIALS MADE OF PLASTIC.
-  USE FOAM CONTROLLED LIQUID DETERGENT IN YOUR MACHINE.
-  HAVE THE DETERGENT FIRM DOSING APPARATUS TO SUPPLY DETERGENT INTO YOUR MACHINE CONNECT.
-  HAVE THE DETERGENT FIRM DOSING APPARATUS TO SUPPLY POLISHER INTO YOUR MACHINE CONNECT.
-  CHECK THE WATER SUPPLY HOSE AND WATER DRAINAGE CONNECTION.
-  FIX OVERFLOW PIPE INTO ITS PLACE.
-  OPEN THE VALVE OF PRESSURED HOT WATER SUPPLY.
-  PLACE THE BASKET, IN WHICH YOU PLACE THE THINGS TO BE WASHED, IN MACHINE.

## DMH001 & DMH002

-  CLOSE THE DEVICE COVER.
-  BRING THE SWITCH FROM THE POSITION “O” INTO POSITION “I”. IN THIS CASE, CONTROL LAMP LIGHTS ON.
-  MACHINE TAKES THE WATER INTO THE TANK AND HEATS UP IT. WHEN THE WATER IS READY, LAMP “READY” LIGHTS ON.
-  WHEN THE COVER OF THE MACHINE IS OPENED AND CLOSED, PROGRAM STARTS AUTOMATICALLY.
-  WASHING TIME CAN BE ADJUSTED AS 30 SECONDS FOR THE 1ST PROGRAM, 60 SECONDS FOR 2ND PROGRAM 90 SECONDS FOR 3RD PROGRAM.

- i** DURING WASHING AND STOPPING, THE LAMP “IT IS WASHING” LIGHTS ON. AFTER 4 SECONDS FROM STOPPING OF RINSING, THIS LAMP LIGHTS OFF. WHEN THIS LAMP LIGHTS OFF, THE OPERATION PROGRAMMED IS COMPLETED.
- i** OPEN THE COVER AND TAKE THE POTS OUT. YOU CAN LOAD THE MACHINE TO BE WASHED INTO THE MACHINE. WHEN THE COVER IS OPENED, THE MACHINE STOPS.
- i** IF THE COVER IS OPENED OR CLOSED AFTER THE PROGRAM STARTS, PROGRAM CONTINUES TO RUN FROM THE POINT IT STOPS.
- i** BRING THE SWITCH INTO POSITION “AW” IN ORDER TO MAKE MANUALLY WASHING.
- i** BRING THE SWITCH INTO POSITION “AR” IN ORDER TO MAKE AUTOMATICALLY WASHING.
- i** WHEN THE WASHING PUMP OF THE MACHINE ENCOUNTERS ANY FORCING, VOLTAGE FLUCTUATION OR FAILURE, THE LAMP OF THERMAL RELAY IS GOING TO LIGHT ON. IN THIS CASE, OPENING THE CONTROL PANEL OF THE MACHINE, ONE MUST PRESS ON THE RESET BUTTON OF THERMAL RELAY.
- i** BE CAREFUL OF NOT RUNNING THE COVER HOLDER, AFTER OPENING THE COVER.

## CONTROL PANEL

FULL AUTOMATIC WASHING CYCLE AT 55 C WITH A CHOICE OF THREE DIFFERENT PROGRAMS FROM 1 TO 2 MINUTES.



- A: SWITCH OFF**
- B: PROGRAM 1**
- C: PROGRAM 2**
- D: AW PROGRAM (WASHING)**
- E: PROGRAM 3**
- F: AP PROGRAM (RINSING)**
- G: WASH READY**
- H: WASH ON**
- J: THERMIC CONTACTOR OFF**

## 12. ELECTRIC DIAGRAM

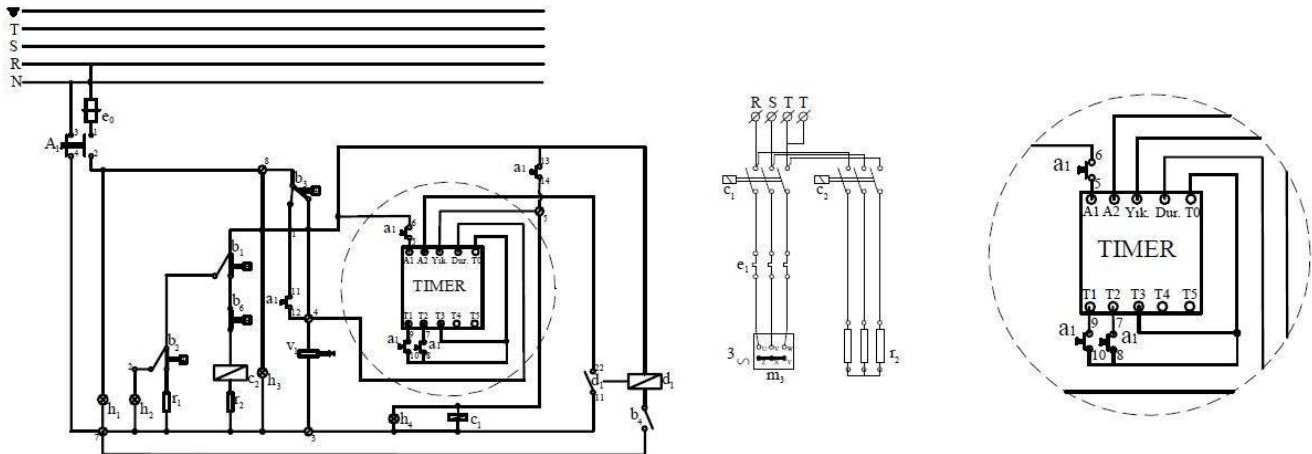

- |   |                                  |
|---|----------------------------------|
| <b>A1. PROGRAM SELECTOR SWITCH</b>                | <b>H1. ENERGY “ON” LAMP</b>      |
| <b>B1. BOILER THERMOSTAT (85°)</b>                | <b>H2. WASHING READY LAMP</b>    |
| <b>B2. TANK THERMOSTAT (55°) /TANK THERMOSTAT</b> | <b>H3. THERMAL ERROR LAMP</b>    |
| <b>B3. PRESSURE SWITCH</b>                        | <b>H4. WASHING LAMP</b>          |
| <b>B4. HOOD SWITCH</b>                            | <b>M3. WASHING PUMP (1,5 HP)</b> |
| <b>B5. TIMER</b>                                  | <b>R1. TANK HEATER (3000W)</b>   |
| <b>B6. LIMIT THERMOSTAT</b>                       | <b>R2. BOILER HEATER (9000W)</b> |
| <b>C1. WASHING PUMP CONTACTOR (9A)</b>            | <b>VI. SOLENOID VALVE</b>        |
| <b>C2. BOILER HEATER CONTACTOR(15A)</b>           | <b>DI. RELAY</b>                 |
| <b>E1. WASHING PUMP TERMIC RELAY</b>              | <b>EO. CIRCUIT BREAKER (16A)</b> |

## 13. MAINTENANCE AND CLEANING

IMPLEMENT THE FOLLOWING PERIODICAL MAINTENANCE SO THAT THE PRODUCT SHOULD WORK IN SAFE AND LONG LIFE:

### DAILY MAINTENANCE



WHEN THE WATER IN WASHING TANK GETS DIRTY, IT MUST BE REPLACED BY FRESH WATER. FOR THIS PURPOSE, BRING THE “O-I” SWITCH OF THE MACHINE INTO “O” POSITION AND CLOSE THE DEVICE.















SWITCH OFF THE ELECTRICITY, SWITCHING OFF THE SWITCH.















OPENING THE COVER OF THE DEVICE, SPONGE THE SOLID WASTES IN THE DEVICE

## CLEANING THE DEVICE

-  WHEN THE WATER IN WASHING TANK GETS DIRTY, IT MUST BE REPLACED BY FRESH WATER.
-  FOR THIS PROPOSE, BRING THE STAND BY AND START SWATCHES OF THE MACHINE INTO “STOP” AND CLOSE THE DEVICE.
-  CLOSING THE SWITCH, SWITCH THE ELECTRICITY OFF.
-  AFTER OPENING THE COVER, BE CAREFUL OF NOT IMPACTING THE COVER HOLDER.
-  TAKE OUT THE OVERFLOW PIPE.
-  REMOVE THE WASHING AND RINSING BUTTERY NOZZLES AND CLEAN THEM. WASH THE RINSING NOZZLES AND RINSE THEM.
-  TAKING OUT THE SURFACE FILTERS AND PUMP SUCTION FILTERS, CLEAN THEM BY BRUSH UNDER THE FLOWING WATER.
-  FIX ALL PARTS IN THEIR PLACE IN SUCH A WAY CONFORMING TO THEIR ORIGINAL CONDITIONS.
-  CLOSE THE COVER OF THE DEVICE.
-  OPEN THE RELEVANT SWITCH ON THE CONTROL PANEL SUPPLYING ELECTRIC TO THE DEVICE. BRING THE “STAND BY” AND “START” SWITCHES INTO STARTING POSITION.
-  FOR COMPLETE CLEANING OF THE DEVICE, RUN THE DEVICE FOR 5 MINUTES
-  BRING THE “START” SWITCH INTO” PAUSE” POSITION.
-  OPEN THE COVER.

## WEEKLY MAINTENANCE

-  WHEN THE WATER IN WASHING TANK GETS DIRTY, IT MUST BE REPLACED BY FRESH WATER.
-  FOR THIS PURPOSE, BRING THE STAND BY AND START SWATCHES OF THE MACHINE INTO “STOP” AND CLOSE THE DEVICE.
-  CLOSING THE SWITCH, SWITCH THE ELECTRICITY OFF.
-  AFTER OPENING THE COVER, BE CAREFUL OF NOT IMPACTING THE COVER HOLDER.
-  TAKE OUT THE OVERFLOW PIPE.
-  REMOVE THE WASHING AND RINSING BUTTERY NOZZLES AND CLEAN THEM. WASH THE RINSING NOZZLES AND RINSE THEM.
-  TAKING OUT THE SURFACE FILTERS AND PUMP SUCTION FILTERS, CLEAN THEM BY BRUSH UNDER THE FLOWING WATER.
-  FIX ALL PARTS IN THEIR PLACE IN SUCH A WAY CONFORMING TO THEIR ORIGINAL CONDITIONS.
-  CLOSE THE COVER OF THE DEVICE.
-  OPEN THE RELEVANT SWITCH ON THE CONTROL PANEL SUPPLYING ELECTRIC TO THE DEVICE. BRING THE “STAND BY AND “START” SWITCHES INTO STARTING POSITION.
-  FOR COMPLETE CLEANING OF THE DEVICE, RUN THE DEVICE FOR 5 MINUTES
-  BRING THE “START” SWITCH INTO” PAUSE” POSITION.
-  OPEN THE COVER.

# 14. SAFE LIFE

THE SAFE LIFE OF THE PRODUCT IS 5 YEARS.

# 15. INTERVENTION AFTER

## FAILURES / CAUSES

- **DEVICE IS NOT WORKING**
  - CHECK WHETHER THERE IS ELECTRIC SUPPLY TO THE DEVICE.
  - BE SURE THAT THERE IS ELECTRIC SUPPLY TO THE STAND BY AND START SWITCHES
  - BE SURE THAT ELECTRIC SUPPLY TO LEVEL SWITCH AND SOLENOID VALVE.
- **THERE IS NO BEING FILLED:**
  - CHECK THE LEVEL SWITCH.
  - CHECK WHETHER THERE ARE ANY CONTAMINANTS IN THE TUBE IN WASHING TANK
  - BE SURE THAT THERE IS ADEQUATE LEVEL OF WATER IN WASHING TANK.
  - CHECK THE SOLENOID VALVE OPENS AND CLOSES. OPEN AND CLOSE THE SWITCH. IF IT DOES NOT WORK, CHANGE BY NEW ONES.
- **WASHING TANK IS NOT BEING FILLED OR THERE IS NO RINSING:**
  - BE SURE THAT THE TAP SUPPLYING WATER IS OPEN
  - CHECK WHETHER DRAINAGE PIPE IS FIXED IN ITS PLACE OR NOT.
  - BE SURE THAT STAND BY AND START SWITCHES ARE OPEN.
  - BE SURE THAT MAIN FUSE SUPPLYING THE MACHINE IS IN ACTIVE.
  - CHECK THE FUSE OF MACHINE.
  - BE SURE THAT THERE IS NO PLUGGING IN BUTTERY NOZZLES DUE TO CONTAMINANTS.
  - BE SURE THAT SUFFICIENT AMOUNT OF AIR IN AIR HOUSING
  - TAKE OUT THE OVERFLOW PIPE AND EMPTY THE TANK COMPLETELY.
  - IF THIS IS NOT A SOLUTION FOR THE PROBLEM, CHANGE THE LEVEL SWITCH.
  - OPENING AND CLOSING THE STAND BY SWITCH, CHECK THE SOLENOID VALVE. IF IT DOES NOT WORK, CHANGE IT BY NEW ONE.
- **WASHING TANK IS SLOWLY BEING FILLED:**
  - BE SURE THAT THE TAP SUPPLYING WATER IS OPEN.
  - CHECK THE WATER PRESSURE, IF IT IS LOWER THAN 202 KPA, USE THE PRESSURIZING PUMP.
  - REMOVE THE WATER SUPPLYING HOSE. TAKE APART THE FILTER OF SOLENOID VALVE AND CLEAN IT
  - BE SURE THAT RINSING NOZZLES ARE NOT PLUGGED
  - BE SURE THAT OVERFLOW PIPE COMPLETELY SITS IN ITS HOUSING. IF THERE IS PRESSURE REDUCING VALVE, TAKE IT OUT.
- **MACHINE IS NOT HEATING WASHING AND RINSING WATER:**
  - AFTER CHECKING THAT OVERFLOW PIPE IS CONNECTED TO ITS PLACE, BE FILLED THE WASHING TANK.
  - CHECK WHETHER OR NOT THE THERMOSTAT OF RINSING WATER BOILER IS SET TO 80 °C, AND THE THERMOSTAT OF WASHING WATER, TO 50°C
  - CHECK THE CABLES AND THEIR CONNECTIONS.
- **WASHING TANK IS NOT BEING EMPTIED:**
  - WASHING TANK CAN NOT BE EMPTIED DUE TO SOLID WASTES. INSPECT THE WATER DRAINAGE HOSE FROM OVERFLOW PIPE TO SIPHON ON THE GROUND. BE SURE THAT IT IS CLEAN.



- **MACHINE IS NOT EFFICIENTLY WORKING:**
  - BE SURE THAT PUMP SUCTION FILTER IS CLEAN
  - BE SURE THAT THE NOZZLES OF WASHING BUTTERY ARE CLEAN
  - BE SURE THAT ADEQUATE AMOUNT OF DETERGENT IS DELIVERED TO THE MACHINE.
  - SELECTED WASHING PROGRAM IS VERY SHORT DUE TO THE FACT THAT THE POTS ARE DIRTY
  - SELECT THE LONGER PROGRAM AND RUN AGAIN THE MACHINE.
  - CHECK WHETHER WATER TEMPERATURE IN WASHING TANK IS CORRECT OR NOT.
  
- **THERE IS NO DRYING: (MODELS WITH DRYING SYSTEM)**
  - BE SURE THAT THE AMOUNT OF POLISHER INJECTED TO THE MACHINE IS CORRECT
  - CHECK THE THERMOSTAT OF RINSING WATER IS SET TO 80 °C.
  
- **CONDENSATION IN THE GLASSES.**
  - DO NOT STORE THE GLASSES ON A FLAT SURFACE.
  - THE AMOUNT OF DOSED POLISHER IS NOT CORRECT.
  - THE AMOUNT OF DOSED POLISHER IS NOT CORRECT.
  
- **STRIPED GLASSES:**
  - USE ONLY FOAMLESS DETERGENT.
  
- **THERE IS AN EXCESS AMOUNT OF FOAM IN THE WASHING TANK:**
  - WATER TEMPERATURE IN WASHING TANK MUST NOT BE LOWER THAN 50°C.
  - CHECK THE DETERGENT AND POLISHER DOSING APPARATUS. THERE CAN BE EXCESSIVE DOSING
  - BE SURE THAT MACHINE WAS NOT CLEANED BY FOAMED DETERGENT. EMPTY THE TANK AND BOILER.
  - IF FOAMED DETERGENT WAS USED, EMPTY THE TANK AND BE FILLED IT BY FRESH WATER. CONTINUE TO MAKE THIS OPERATION UNTIL THE FOAM DISAPPEAR.
  
- **THERE IS STAIN ON THE GLASS :**
  - DECREASE THE AMOUNT OF DOSED POLISHER.
  - ACCEPTABLE DOSAGE IS 0,1 CC / LITRE WATER.
  
- **THE ARMS OF WASHING BUTTERY ARE NOT CORRECTLY ROTATING:**
  - REMOVE THE WASHING ARM AND CLEAN IT.
  - BE SURE THAT WATER PRESSURE IS MORE THAN 202 KPA, IF THE PRESSURE IS LOWER, MOUNT A PRESSURIZING PUMP.



# 16. SPARE PARTS LIST

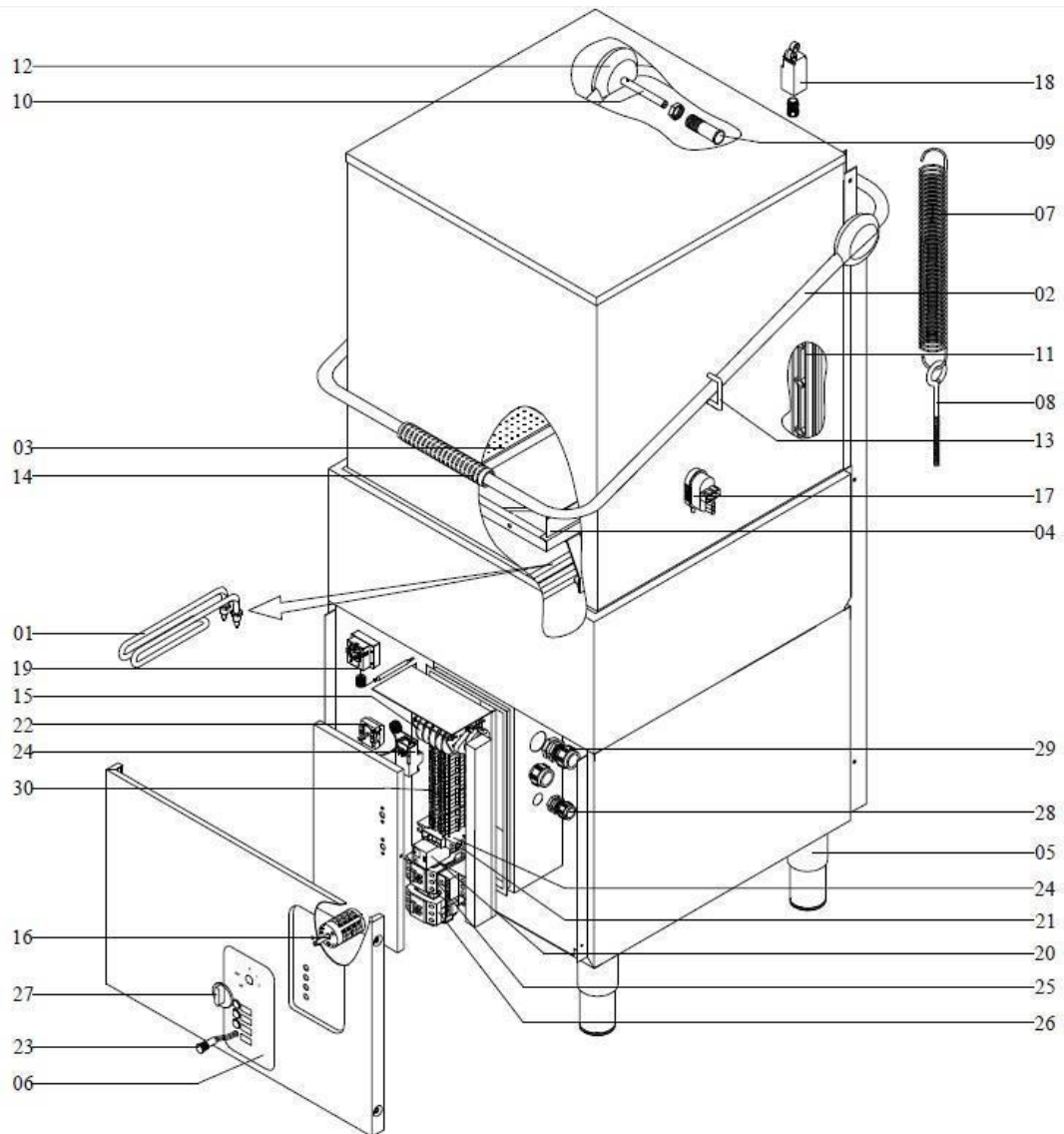

NO	DESCRIPTION	NO	DESCRIPTION	NO	DESCRIPTION
01	Heating Element	12	Pulley	23	Signal Lamp
02	Handle	13	Holder	24	Thermic
03	Filter	14	Handle	25	Contactor
04	Shelf	15	Timer	26	Contactor
05	Foot	16	Switch	27	Timer knob
06	Fascia	17	Pressure Switch	28	Fitting
07	Spring	18	Switch with Pulley	29	Fitting
08	Tension Rod	19	Limiter	30	Connector
09	Bearing	20	Timer		
10	Spindle	21	Socket		
11	Rail	22	Thermostats		

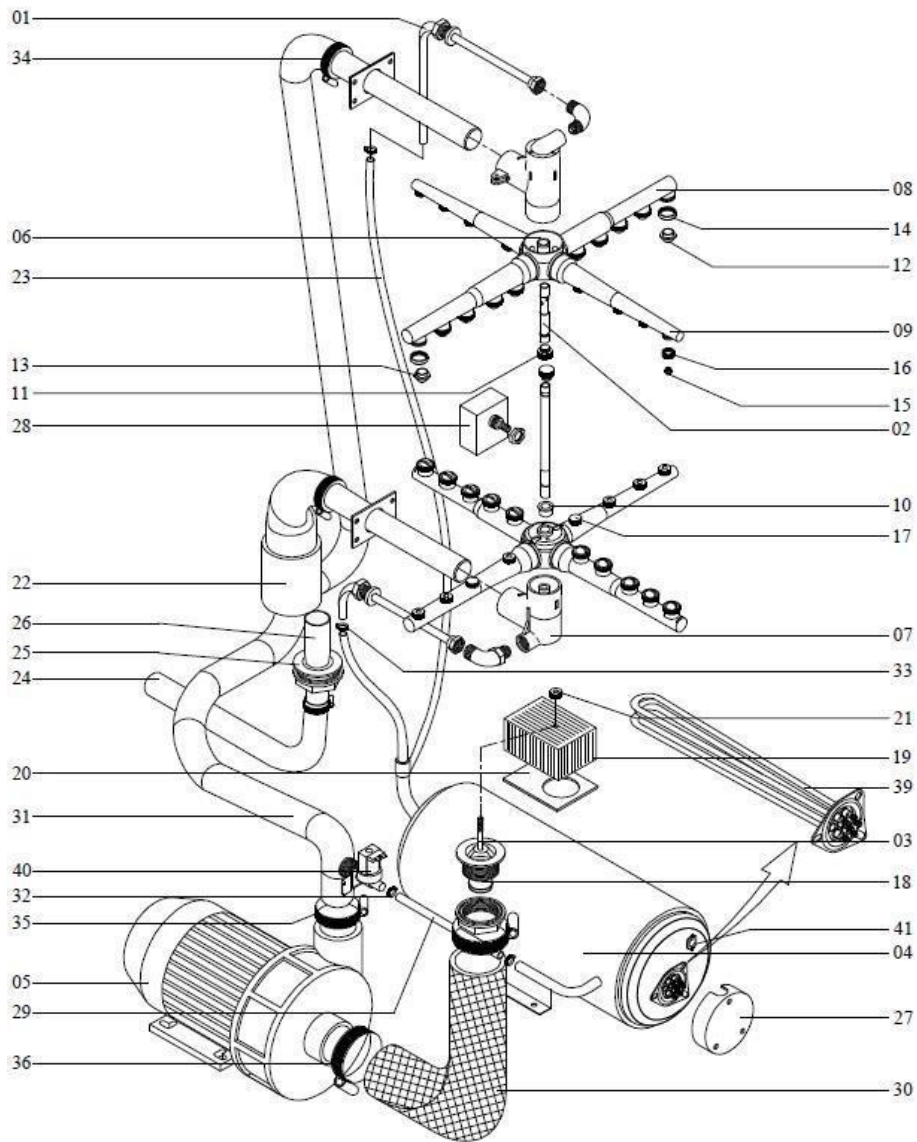

NO	DESCRIPTION	NO	DESCRIPTION	NO	DESCRIPTION	NO	DESCRIPTION
01	Rinse Line	13	Nozzle	25	Drainer	39	Heating Element
02	Shaft	14	Nut	26	Drain Pipe	40	Solenoid Valve
03	Suction Filter	15	Nozzle	27	Lid	41	Limiter
04	Boiler	16	Nut	28	Pressure Pot		
05	Wash Pump	17	Nut	29	Inlet Hose		
06	Body	18	Flange	30	Hose		
07	Faucet	19	Suction Filter	31	Hose		
08	Wash Arm	20	Bottom	32	Clip		
09	Rinse Arm	21	Nut	33	Clip		
10	Terminal	22	Hose	34	Clip		
11	Bolt	23	Hose	35	Clip		
12	Nozzle	24	Drain Hose	36	Clip		

**CONTENDER PASS-THROUGH HOOD DISHWASHER SINGLE PHASE • SKU: DMH001**  
**CONTENDER PASS-THROUGH HOOD DISHWASHER 3 PHASE ELECTRIC • SKU: DMH002**



**STEP UP TO THE PLATE**

**DISTRIBUTED BY RG DISTRIBUTORS LTD. TEL: 0333 358 3678**